

TRASPORTO PESANTE

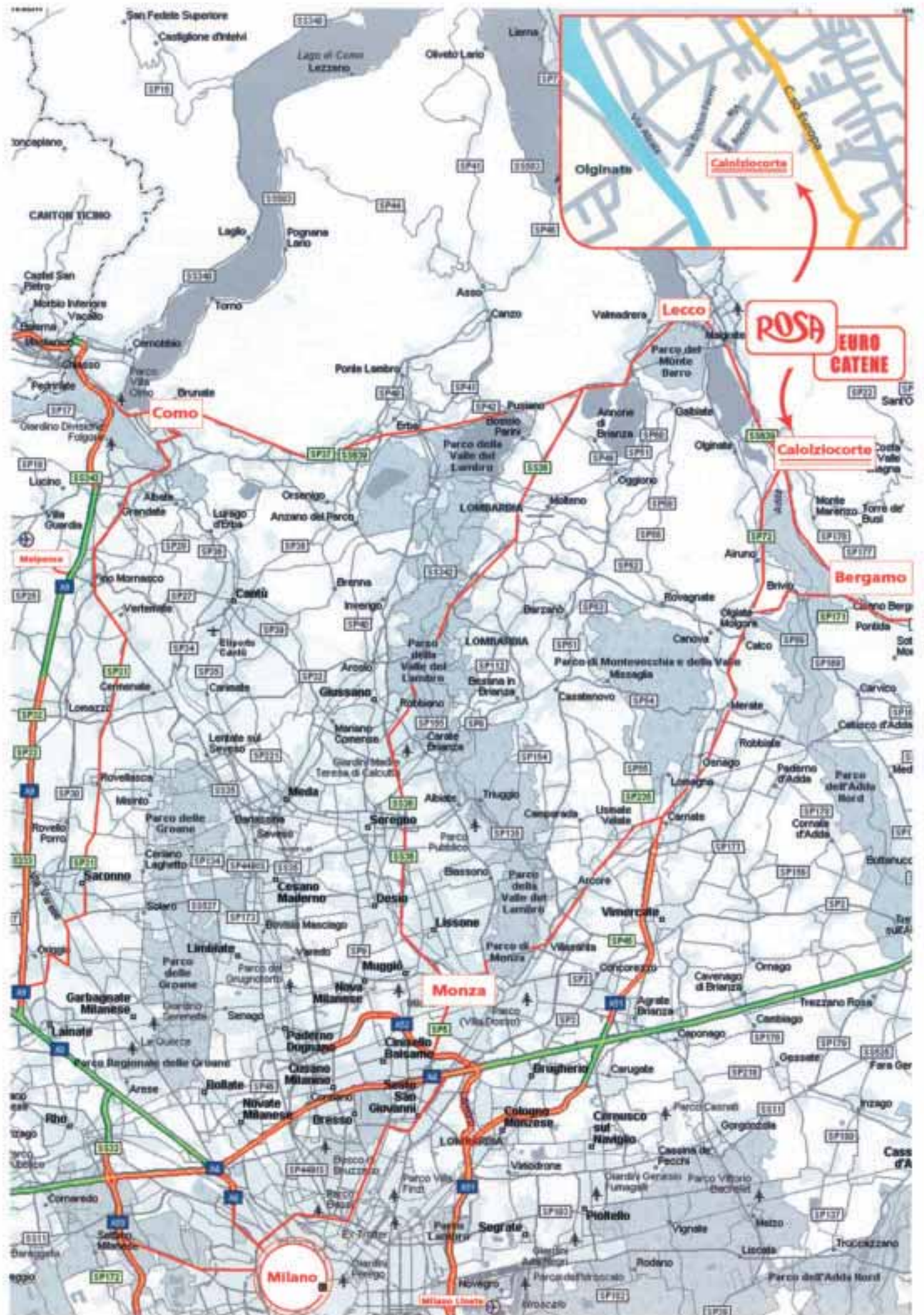

ROSA

**EURO
CATENE**



INDICE

TRASPORTO PESANTE

Glossario delle principali abbreviazioni utilizzate nel catalogo	2
Catene trasporto serie 12 e serie speciale	3
Catene trasporto serie 31	4
Catene trasporto a perno forato serie 12 e serie 31	5
Attacchi per catene trasporto serie 12, 31 e speciale	6
Catene trasporto serie europea (ISO), perni pieni	11
Catene trasporto serie europea (ISO), perni forati	13
Attacchi per catene trasporto serie europea (ISO)	14
Catene trasporto a piastre rialzate serie europea (ISO 1977-DIN 8167)	17
Catene trasporto serie FV, perni pieni	19
Attacchi per catene trasporto serie FV	21
Catene trasporto a perno forato serie FV (DIN 8165)	22
Catene trasporto a piastre rialzate serie FV (DIN 8165)	24
Catene trasporto non unificate, perni pieni rulli piani	26
Catene trasporto non unificate, perni forati rulli pieni	28
Attacchi per catene trasporto non unificate	29
Catene trasporto a standard interno, perni pieni	32
Catene trasporto a standard interno, perni forati	33
Attacchi per catene trasporto a standard interno	34
Catene Speciali	

INDEX

HEAVY CONVEYING

<i>Glossary of the main abbreviations used in the catalog</i>	2
<i>Conveyor chains 12 series and special series</i>	3
<i>Conveyor chains 31 series</i>	4
<i>Hollow pins conveyor chains - 12 series and 31 series</i>	5
<i>Attachments for conveyor chains - 12, 31 and special series</i>	6
<i>Conveyor chains European Standard (ISO), solid pins</i>	11
<i>Conveyor chains European Standard (ISO), solid pins</i>	13
<i>Attachments for conveyor chains European Standard (ISO)</i>	14
<i>Deep link conveyor chains with European Standard (ISO 1977-DIN 8167)</i>	17
<i>Conveyor chains, solid pins</i>	19
<i>Attachments for conveyor chains</i>	21
<i>Hollow pin conveyor chains (DIN 8165)</i>	22
<i>Deep link conveyor chains (DIN 8165)</i>	24
<i>Non standard conveyor chains, solid pins plain rollers</i>	26
<i>Non standard conveyor chains, hollow pins plain rollers</i>	28
<i>Attachments for conveyor chains, non standard</i>	29
<i>Our standard conveyor chains, solid pins</i>	32
<i>Our standard conveyor chains, hollow pins</i>	33
<i>Attachments for conveyor chains, our standard</i>	34
Special Chains	

GLOSSARIO

p	=	Passo
Hi	=	Larghezza interna della maglia interna (min)
Dr	=	Diametro del rullo
Hp	=	Altezza della piastra (max)
s	=	Spessore della piastra
Sj	=	Spessore della piastra interna
Se	=	Spessore della piastra esterna
Dp	=	Diametro del perno (max)
l	=	Lunghezza del perno ribadito (max)
lx	=	Ingombro massimo sulla giunzione
pt	=	Passo trasversale
Db	=	Diametro della bussola (max)
Df	=	Diametro del foro del perno forato
R	=	Raggio minimo di curvatura
L	=	Larghezza dletta
Dc	=	Diametro cuscinetto
Dps	=	Diametro perno sporgente

GLOSSARY

p	=	Pitch
Hi	=	Inside width (min)
Dr	=	Roller diameter
Hp	=	Sidebar height (max)
s	=	Plate thickness
Sj	=	Inner plate thickness
Se	=	Outer plate thickness
Dp	=	Pin diameter (max)
l	=	Riveted pin width (max)
lx	=	Maxim overall width
pt	=	Gauge
Db	=	Bushing diameter (max)
Df	=	Bore pin diameter
R	=	Minimum bending radius
L	=	Attachment width
Dc	=	Bearing diameter
Dps	=	Extended pin diameter



L'azienda
ROSA CATENE
è certificata
UNI EN ISO
9001:2000

ROSA CATENE
is certified
UNI EN ISO
9001:2000



CATENE TRASPORTO - SERIE 12 E SERIE SPECIALE

CONVEYOR CHAINS - 12 SERIES AND SPECIAL SERIES

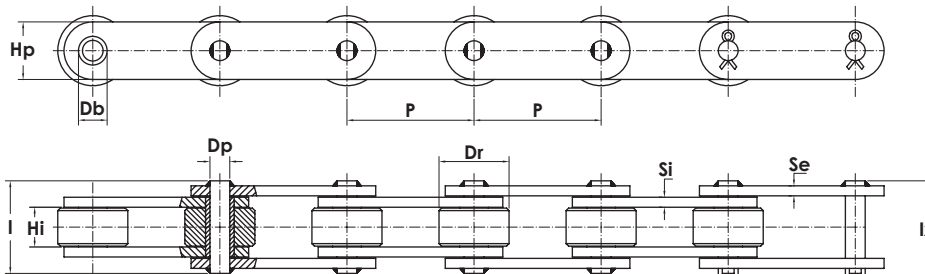

SERIE 12 PERNI PIENI - 12 SERIES SOLID PINS

CODICE CATENA	Dimensioni nominali			Altre dimensioni								Carico minimo di rottura		Peso netto al m. Kg/m	giunto n	TRADE MARK
	passo	largh. interna min.	diam. rullo	altezza max piastra	spess. piastre int.	spess. piastre est.	diam. max perno	diam. bussola	largh. perno ribad.	ingombro max	N Kg	T* Kg				
	P mm	Hi mm	Dr mm	Hp mm	Si mm	Se mm	Dp mm	Db mm	I mm	Ix mm						
• 1201/162 • 1206/162	50 100	12	25	16	2,0	2,0	5,70	8,05	25	31	1.800	2.400	1,55 1,02	21	EURO CATENE	
• 1201/163 • 1206/163	50 100	12	25	16	3,0	3,0	5,70	8,05	28	34	1.800	3.500	1,85 1,30	21		
• 1201/182 • 1203/182 • 1204/182 • 1205/182	50 69 70 75	12	25	18	2,0	2,0	5,70	8,05	25	31	1.800	2.900	1,63 1,34 1,33 1,28	21		
• 1201/185 • 1203/185 • 1204/185 • 1205/185	50 69 70 75	12	25	18	2,5	2,5	5,70	8,05	26	32	1.800	3.500	1,81 1,51 1,50 1,44	21		
• 1201/183 • 1203/183 • 1204/183 • 1205/183	50 69 70 75	12	25	18	3,0	3,0	5,70	8,05	28	34	1.800	3.500	1,99 1,68 1,67 1,61	21		
• 1201/203 • 1202/203 • 1209/203	50 60 63	12	25	20	3,0	3,0	5,70	8,05	28	34	1.800	3.500	2,05 1,94 1,89	21		
• 1201/203/R	50	12	25	20	3,0	3,0	7,92	11,00	28	34	2.700	5.000	2,11	21		

SERIE SPECIALE PERNI PIENI - SPECIAL SERIES SOLID PINS

CODICE CATENA	Dimensioni nominali			Altre dimensioni								Carico minimo di rottura		Peso netto al m. Kg/m	giunto n	TRADE MARK
	passo	largh. interna min.	diam. rullo	altezza max piastra	spess. piastre int.	spess. piastre est.	diam. max perno	diam. bussola	largh. perno ribad.	ingombro max	N Kg	T* Kg				
	P mm	Hi mm	Dr mm	Hp mm	Si mm	Se mm	Dp mm	Db mm	I mm	Ix mm						
• SP4G/500 ▲	50	17	15,88	25	3	3	8,28	11,45	35,5	40	3.200	5.900	1,98	21	EURO CATENE	
• SP4B/508	50,8	15	18,00	25	4	4	10,00	13,35	38,0	44	4.200	7.000	2,82	21		
• SP4K/635	63,5	24	45,00	40	4	4	13,35	19,05	47,0	55	7.000	12.000	8,40	21		
• SP4T/635 Δ	63,5	46	19,05	40	6	6	13,35	19,05	78,5	87	8.900	17.500	7,37	21		
• SP4R/700	70	14	20,00	25	4	4	10,00	13,35	38,0	44	4.200	7.000	2,65	21		
• SP4V/750	75	17	15,88	25	4	4	8,28	11,45	40,0	45	4.500	7.300	2,54	21		
• SP4A/750 Δ	75	18	17,00	35	4	4	10,00	13,35	41,0	47	5.500	11.000	3,47	21		
• SP4C/100	100	14	26,00	25	4	4	10,00	13,35	37,0	43	4.200	7.000	2,49	21		
• SP4F/75	75	25	40,00	35	4	4	10,00	13,35	47,0	55	8.200	11.000	6,21	21		
• SP4F/100	100	25	40,00	35	4	4	10,00	13,35	47,0	55	8.200	11.000	5,39	21		

Δ Catene a bussolle / Bush chain

▲ Catena con piastra a profilo sagomato / Chain with shaped plates

*T Carico di rottura per catene con piastre trattate / Breaking load with heat treated plates

CATENE TRASPORTO - SERIE 31

CONVEYOR CHAINS - 31 SERIES

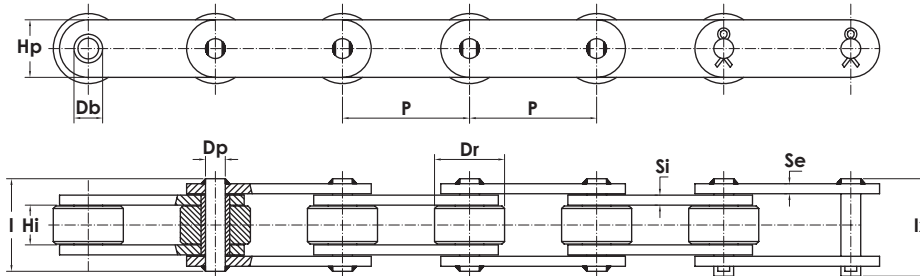

SERIE 31 PERNI PIENI - 31 SERIES SOLID PINS

CODICE CATENA	Dimensioni nominali			Altre dimensioni								Carico minimo di rottura		Peso netto al m. Kg/m	giunto n	TRADE MARK										
	passo P	largh. interna min. Hi	diam. rullo Dr	altezza max piastra Hp	spess. piastre int. Si	spess. piastre est. Se	diam. max perno Dp	diam. bussola Db	largh. perno ribad. I	ingombro max lx	N Kg	T* Kg														
	P mm	Hi mm	Dr mm	Hp mm	Si mm	Se mm	Dp mm	Db mm	I mm	lx mm	N Kg	T* Kg	Kg/m	n												
• 3127/50 ▲	50	15	31	25	3	3	10	13,35	34	40	3.500	6.000	3,27	21	EURO CATENE											
• 3130/50	50	15	31	25	3	3	10	13,35	34	40	3.500	6.000	3,44	21												
• 3130/58	50,8												3,41													
• 3130/63	63,5												2,96													
• 3130/70	70												2,80													
• 3130/75	75												2,69													
• 3130/76	76,2												2,67													
• 3130/100	100												2,31													
• 3130/101	101,6												2,29													
• 3130/125	125												2,09													
• 3130/150	150												1,94													
• 3130/152	152,4	1,92																								
• 3130/200	200	1,75																								
• 3142/50	50	15	31	25	4	4	10	13,35	38	44	4.700	8.200	3,98	21												
• 3142/58	50,8												3,94													
• 3142/63	63,5												3,47													
• 3142/70	70												3,29													
• 3142/75	75												3,18													
• 3142/76	76,2												3,15													
• 3142/100	100												2,78													
• 3142/101	101,6												2,76													
• 3142/125	125												2,54													
• 3142/150	150												2,38													
• 3142/152	152,4												2,36													
• 3142/200	200												2,18													
• 3155/50	50												15		31	35	4	4	10	13,35	38	44	5.500	11.000	5,20	21
• 3155/58	50,8																								5,15	
• 3155/63	63,5	4,56																								
• 3155/70	70	4,34																								
• 3155/75	75	4,20																								
• 3155/76	76,2	4,17																								
• 3155/100	100	3,70																								
• 3155/101	101,6	3,68																								
• 3155/125	125	3,40																								
• 3155/150	150	3,20																								
• 3155/152	152,4	3,18																								
• 3155/200	200	2,95																								

▲ Catena con piastre a profilo sagomato / Chain with shaped plates

*T Carico di rottura per catene con piastre trattate / Breaking load with heat treated plates

CATENE TRASPORTO A PERNO FORATO - SERIE 12 E SERIE 31

HOLLOW PINS CONVEYOR CHAINS - 12 SERIES AND 31 SERIES

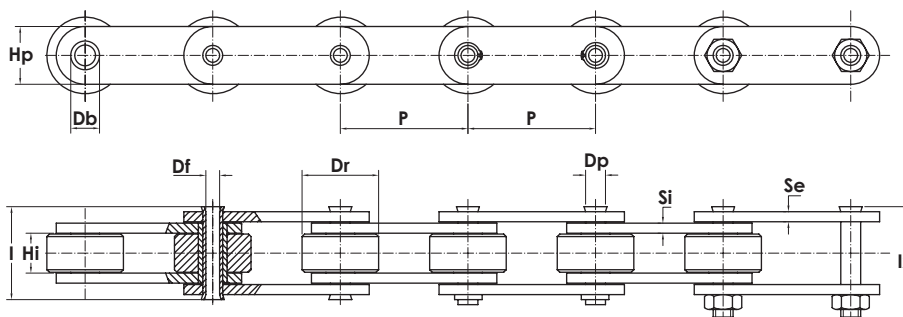

SERIE 12 - 12 SERIES

CODICE CATENA	Dimensioni nominali			Altre dimensioni								Carico minimo di rottura		Peso netto al m.	giunto	TRADE MARK
	passo	largh. interna min.	diam. rullo	altezza max piastra	spess. piastre int.	spess. piastre est.	diam. max perno	diam. foro perno	diam. bussola	largh. perno ribad	ingombro max	N	T*			
	P mm	Hi mm	Dr mm	Hp mm	Si mm	Se mm	Dp mm	Df mm	Db mm	l mm	lx mm	Kg	Kg	Kg/m	n	
• 1201/205 PF	50	12,00	25	20	3,00	3,00	8,60	6,25	11	28,00	30,00	2.000	3.200	2,00	27	EURO CATENE
• 1201/205 PFX*	50	11,50	25	20	2,50	2,50	9,00	6,25	11	26,00	28,00	2.500	-	1,80	27	
• 1201/205 PFR	50	11,50	25	20	2,50	2,50	9,00	6,25	11	26,00	28,00	-	3,800	1,80	27	
• 1201/235 ▲	50	11,50	25	23	2,50	2,50	13,20	10,50	16	25,00	27,50	1.630	-	1,55	27	
• D3209	50	11,50	31,75	25	3,00	3,00	10,00	6,20	13,30	28,00	30,00	-	5.096	2,90	27	
• 1205/205 PF	75	11,00	25	20	2,50	2,50	9,00	6,25	11	26,50	30,00	2.000	3.200	1,48	27	

* Catene in acciaio inossidabile / Stainless steel chain

▲ Catene con piastre a profilo sagomato / Chain with shaped plates

T Carico di rottura per catene con piastre trattate / Breaking load with heat treated plates

SERIE 31 - 31 SERIES

CODICE CATENA	Dimensioni nominali			Altre dimensioni								Carico minimo di rottura		Peso netto al m.	giunto	TRADE MARK
	passo	largh. interna min.	diam. rullo	altezza max piastra	spess. piastre int.	spess. piastre est.	diam. max perno	diam. foro perno	diam. bussola	largh. perno ribad	ingombro max	N	T*			
	P mm	Hi mm	Dr mm	Hp mm	Si mm	Se mm	Dp mm	Df mm	Db mm	l mm	lx mm	Kg	Kg	Kg/m	n	
• 3130/50 PF	50				3	3					31	34	2.400	3.500	3,00	EURO CATENE
• 3124/50 PF	50														3,54	
• 3124/58 PF	50,8														3,51	
• 3124/63 PF	63,5														3,12	
• 3124/75 PF	75														2,88	
• 3124/76 PF	76,2	15	31	25	4	4	13,35	10,2	17	36,5	52	3.200	4.100	2,88	26-27	
• 3124/100 PF	100														2,56	
• 3124/101 PF	101,6														2,54	
• 3124/125 PF	125														2,36	
• 3124/150 PF	150														2,23	
• 3124/152 PF	152,4														2,22	
• 3124/200 PF	200														2,07	

* T Carico di rottura per catene con piastre trattate / Breaking load with heat treated plates

ATTACCHI PER CATENE TRASPORTO - SERIE 12, 31 E SPECIALE

ATTACHMENTS FOR CONVEYOR CHAINS - 12, 31 AND SPECIAL SERIES

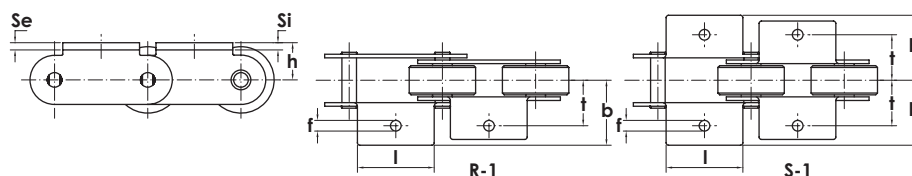

TIPO R-1 S-1 - TYPE R-1 S-1

CATENA CODICE	passo	Dimensioni							Sovrappeso unitario approssimato attacco	
		altezza aletta	lunghezza aletta	diam. foro aletta	interasse trasversale fori	ingombro trasversale aletta	spessore esterne	spessore interne	R-1 Kg	S-1 Kg
		p mm	h mm	l mm	f mm	t mm	b mm	Se mm		
• 1201/162	50	22,5	42,5	6,5	24,0	34,5	2,0	2,0	0,026	0,052
• 1201/163	50	23,5	42,5	6,5	25,5	36,0	3,0	3,0	0,040	0,079
• 1201/182	50	23,5	41,5	6,5	21,0	32,5	2,0	2,0	0,025	0,049
• 1201/183	50	24,5	41,5	6,5	22,0	33,6	3,0	3,0	0,037	0,073
• 1201/185	50	24,0	41,5	6,5	21,5	33,0	2,5	2,5	0,031	0,061
• 1201/185■	50	12,5	41,5	8,5	34,3	45,5	2,5	2,5	0,030	0,059
• 1202/203	60	24,0	45,6	7,5	23,0	36,7	3,0	3,0	0,040	0,080
• 1206/162	100	15,0	41,0	7,9	25,5	45,0	2,0	2,0	0,028	0,055
• 1206/163	100	15,5	41,0	7,9	26,5	45,8	3,0	3,0	0,042	0,083
• 1209/203	63	20,5	53,2	8,0	26,6	44,8	3,0	3,0	0,053	0,106
• 3127/50	50	20,0	44,5	10,5	25,5	42,5	3,0	3,0	0,039	0,078
• 3127/50 △	50	20,0	60,5	10,5	26,0	44,0	3,0	-	0,056	0,112
• 3127/50 □	50	35,0	60,5	10,2	30,0	48,0	3,0	-	0,082	0,163
• 3130/50	50	20,0	44,5	10,5	25,5	42,5	3,0	3,0	0,039	0,078
• 3142/50	50	20,0	44,5	10,5	27,0	44,0	4,0	4,0	0,052	0,104
• 3155/75	75	30,0	55,0	10,5	38,7	56,0	4,0	4,0	0,089	0,178
• 3155/76	76,2	30,0	55,0	10,5	38,7	56,0	4,0	4,0	0,089	0,178
• 3155/100	100	26,0	70,0	13,0	35,0	60,6	4,0	4,0	0,113	0,225
• 3155/101	101,6	26,0	70,0	13,0	35,0	60,6	4,0	4,0	0,113	0,225
• SP4B/508	50,8	20,0	44,5	10,5	27,0	44,0	4,0	4,0	0,052	0,104
• SP4K/635	63,5	27,0	50,0	8,5	40,0	58,0	4,0	4,0	0,069	0,138
• SP4T/635	63,5	30,0	50,0	11,0	55,0	71,0	6,0	6,0	0,109	0,217
• SP4A/750	75	24,0	55,0	10,0	36,0	58,0	4,0	4,0	0,085	0,170
• SP4F/75	75	26,0	55,0	16,5	38,0	66,0	4,0	4,0	0,085	0,170
• SP4F/100	100	26,0	70,0	17,0	38,0	66,0	4,0	4,0	0,121	0,242

- Aletta con piega a filo rullo
- △ Aletta bassa
- Aletta alta

ATTACCHI PER CATENE TRASPORTO - SERIE 12, 31 E SPECIALE

ATTACHMENTS FOR CONVEYOR CHAINS - 12, 31 AND SPECIAL SERIES

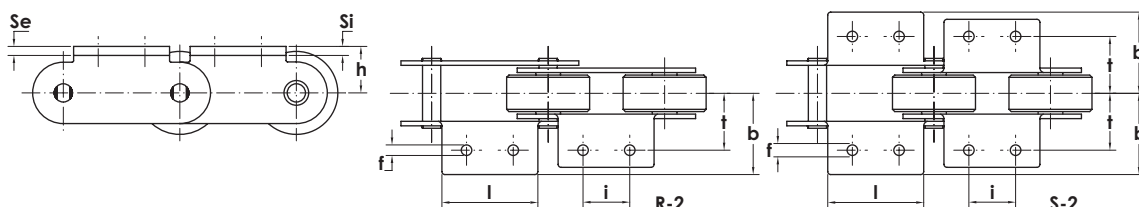

TIPO R-2 S-2 - TYPE R-2 S-2

CATENA CODICE	passo p mm	Dimensioni								Sovrappeso unitario approssimato attacco	
		altezza aletta h mm	lunghezza aletta l mm	diam. fori aletta f mm	interasse trasversale fori t mm	ingombro trasversale aletta b mm	interasse longitud. fori i mm	spessore esterne Se mm	spessore interne Si mm	R-2 Kg	S-2 Kg
• 1201/163	50	23,5	42,5	6,5	25,5	36,0	25,0	3,0	3,0	0,040	0,079
• 3127/50	50	17,0	60,4*	8,5	31,0	46,8	25,0	3,0	-	0,058	0,115
• 3130/50	50	17,0	60,4*	8,5	31,0	46,8	25,0	3,0	-	0,058	0,115
• 3130/75	75	24,0	65,0	6,5	35,5	42,8	44,7	3,0	3,0	0,063	0,126
• 3130/76	76,2	24,0	65,0	6,5	35,5	42,8	44,7	3,0	3,0	0,063	0,126
• 3130/100	100	31,0	68,3	10,5	32,0	49,8	40,0	3,0	3,0	0,085	0,169
• 3130/101	101,6	18,0	68,3	10,5	37,0	64,0	30,0	3,0	3,0	0,085	0,169
• 3142/50	50	17,5	60,4	9,0	34,0	48,0	30,0	4,0	-	0,077	0,153
• 3142/58	50,8	17,5	60,4	9,0	34,0	48,0	30,0	4,0	-	0,077	0,153
• 3142/70	70	24,0	65,0	6,5	36,5	44,0	44,7	4,0	4,0	0,084	0,168
• 3142/75	75	24,0	65,0	6,5	36,5	44,0	44,7	4,0	4,0	0,084	0,168
• 3142/76	76,2	24,0	65,0	6,5	36,5	44,0	44,7	4,0	4,0	0,084	0,168
• 3142/100	100	32,0	68,3	10,5	34,0	50,8	40,0	4,0	4,0	0,113	0,226
• 3155/75	75	30,0	55,0	10,5	38,7	56,0	30,0	4,0	4,0	0,085	0,170
• 3155/76	76,2	30,0	55,0	10,5	38,7	56,0	30,0	4,0	4,0	0,085	0,170
• 3155/100	100	26,0	70,0	13,0	35,0	60,6	40,0	4,0	4,0	0,105	0,210
• 3155/101	101,6	26,0	70,0	13,0	35,0	60,6	40,0	4,0	4,0	0,105	0,210
• SP4B/508	50,8	17,5	60,4	9,0	34,0	48,0	30,0	4,0	-	0,077	0,153
• SP4R/700	70	24,0	65,0	6,5	36,0	43,5	44,7	4,0	4,0	0,084	0,168
• SP4V/750	75	24,0	65,0	6,5	37,5	45,0	44,7	4,0	4,0	0,084	0,168
• SP4C/100	100	32,0	68,3	10,5	33,5	57,0	40,0	4,0	4,0	0,113	0,226

* Montate solo sulle maniglie esterne / Only on outer links

ATTACCHI PER CATENE TRASPORTO - SERIE 12, 31 E SPECIALE

ATTACHMENTS FOR CONVEYOR CHAINS - 12, 31 AND SPECIAL SERIES

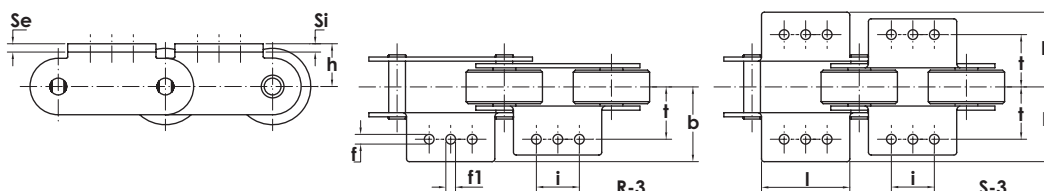

TIPO R-3 S-3 - TYPE R-3 S-3

CATENA CODICE	passo p mm	Dimensioni									Sovrappeso unitario approssimato attacco	
		altezza aletta h mm	lunghezza aletta l mm	diam. fori aletta f mm	diam. foro centrale f ₁ mm	interasse trasversale fori t mm	ingombro trasversale aletta b mm	interasse longitud. fori i mm	spessore esterne S _e mm	spessore interne S _i mm	R-3 Kg	S-3 Kg
• 1203/182	69	24,0	64,1	6,5	6,5	23,5	35,5	46,5	2,0	2,0	0,040	0,080
• 1203/183	69	24,0	64,1	6,5	6,5	25,0	38,0	46,5	3,0	3,0	0,060	0,120
• 1203/185	69	24,0	64,1	6,5	6,5	24,0	36,0	46,5	2,5	2,5	0,050	0,099
• 1204/182	70	24,0	64,1	6,3	6,3	23,5	35,5	46,5	2,0	2,0	0,040	0,080
• 1204/183	70	24,0	64,1	6,3	6,3	25,0	38,0	46,5	3,0	3,0	0,060	0,120
• 1204/185	70	24,0	64,1	6,3	6,3	24,0	36,0	46,5	2,5	2,5	0,050	0,099
• 1205/182	75	24,0	64,1	6,3	6,3	23,5	35,5	46,5	2,0	2,0	0,040	0,080
• 1205/183	75	24,0	64,1	6,3	6,3	25,0	38,0	46,5	3,0	3,0	0,060	0,120
• 1205/185	75	24,0	64,1	6,3	6,3	24,0	36,0	46,5	2,5	2,5	0,050	0,099
• 3127/50	50	17,0	60,4	8,5	8,5	31,0	46,8	25,0	3,0	-	0,054	0,108
• 3130/50	50	17,0	60,4	8,5	8,5	31,0	46,8	25,0	3,0	-	0,054	0,108
• 3130/75	75	30,0	64,8	9,0	9,0	29,0	51,0	30,0	3,0	3,0	0,078	0,156
• 3130/76	76,2	30,0	64,8	9,0	9,0	29,0	51,0	30,0	3,0	3,0	0,078	0,156
• 3130/100	100	31,0	68,3	10,5	6,0	32,0	49,8	40,0	3,0	3,0	0,081	0,162
• 3130/101	101,6	31,0	68,3	10,5	6,0	32,0	49,8	40,0	3,0	3,0	0,081	0,162
• 3142/50	50	17,5	60,4	9,0	9,0	34,0	48,0	30,0	4,0	-	0,072	0,144
• 3142/75	75	30,5	64,8	9,0	9,0	29,5	52,0	30,0	4,0	4,0	0,104	0,208
• 3142/76	76,2	30,5	64,8	9,0	9,0	29,5	52,0	30,0	4,0	4,0	0,104	0,208
• 3142/100	100	32,0	68,3	10,5	6,0	34,0	50,8	40,0	4,0	4,0	0,108	0,215
• 3142/101	101,6	32,0	68,3	10,5	6,0	34,0	50,8	40,0	4,0	4,0	0,108	0,215
• SP4B/508	50,8	17,5	60,4	9,0	9,0	34,0	48,0	30,0	4,0	-	0,072	0,144
• SP4R/700	70	30,5	64,8	9,0	9,0	29,0	51,5	30,0	4,0	4,0	0,104	0,208
• SP4V/750	75	30,5	64,8	9,0	9,0	30,5	53,0	30,0	4,0	4,0	0,104	0,208
• SP4C/100	100	32,0	68,3	10,5	6,0	33,5	57,0	40,0	4,0	4,0	0,108	0,215

ATTACCHI PER CATENE TRASPORTO - SERIE 12, 31 E SPECIALE

ATTACHMENTS FOR CONVEYOR CHAINS - 12, 31 AND SPECIAL SERIES

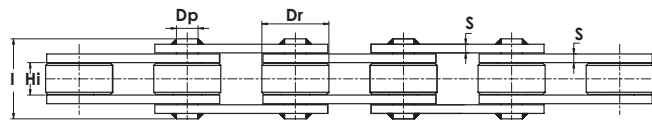
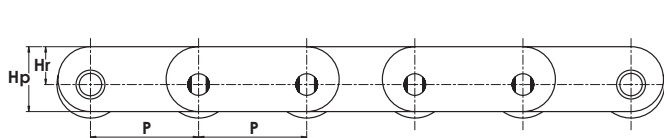

TIPO PIASTRE RIALZATE STILE N - DEEP LINK

CODICE CATENA	Dimensioni nominali			Altre dimensioni							Carico minimo di rottura		TRADE MARK
	passo	largh. interna min.	diam. rullo	altezza max piastra	altezza rialzo	spess. piastre	diam. max perno	diam. bussola	largh. perno ribad.	ingombro max	N Kg	T* Kg	
	p mm	Hi mm	Dr mm	Hp mm	Hr mm	S mm	Dp mm	Db mm	l mm	lx mm			
• D0734	50	12,00	25	25	16,50	3,0	5,70	8,05	28,0	30,0	2.700	3.500	EURO CATENE
• D0780	50	15,00	31	30	17,50	4,0	10,00	13,35	37,0	40,0	6.000	8.200	
• D1686	100	15,00	31	30	17,50	4,0	10,00	13,35	37,0	40,0	6.000	8.200	

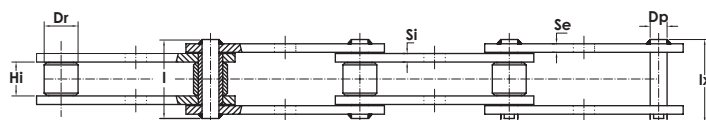
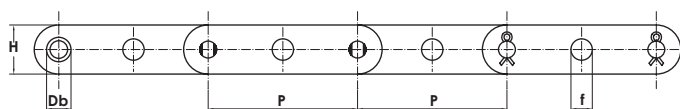

TIPO T-1 PERNI PIENI - TYPE T-1 SOLID PINS

CODICE CATENA	Dimensioni nominali			Altre dimensioni								Carico minimo di rottura ▲	Peso netto al m.	giunto	TRADE MARK
	passo	largh. interna min.	diam. rullo	altezza max piastra	spess. piastre int.	spess. piastre est.	diam. max perno	diam. bussola	largh. perno ribad.	ingombro max	diam. foro centrale				
	P mm	Hi mm	Dr mm	Hp mm	Si mm	Se mm	Dp mm	Db mm	l mm	lx mm	f mm				
• 1204/181	70	11,5	15,0	18	2,0	2,0	5,70	8,05	22,5	25,0	8,5	2.000	0,89	21	EURO CATENE

TIPO H-1 - TYPE H-1

CODICE CATENA	Dimensioni *			Sovrappeso unitario approx attacco
	diam. perno sporgente	sporgenza da centro catena	sporgenza da piano piast. est.	
	Dp1 mm	m mm	n mm	
• 12../162	12,00	20,5	10,0	0,008
• 12../163	12,00	32,5	20,0	0,016
• 12../182	12,00	35,5	25,0	0,021
• 12../183	6,0	32,5	20,0	0,004
• 12../185	12,00	51,5	40,0	0,034
• 12../203	12,00	32,5	20,0	0,016
• 3127/...	10,00	34,0	20,0	0,011
• 3130/...	12,00	34,0	20,0	0,016
• 3142/...	16,00	41,0	25,0	0,035
• 3155/...	12,00	61,0	45,0	0,038
• SP4G/500	8,28	35,0	20,0	0,008
• SP4B/508	10,00	36,0	20,0	0,011
• SP4K/635	13,35	50,5	30,0	0,030
• SP4T/635	13,35	75,5	40,0	0,040
• SP4R/700	10,00	35,5	20,0	0,011
• SP4V/750	8,28	37,0	20,0	0,008
• SP4A/750	10,00	47,5	30,0	0,017
• SP4C/100	10,00	35,5	20,0	0,011
• SP4F/100	10,00	51,0	30,0	0,017

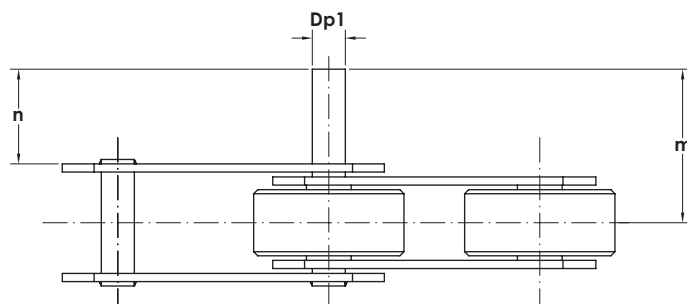
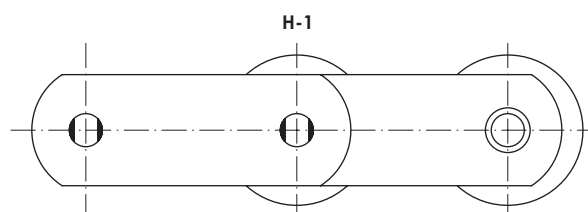

▲ Carico di rottura per catene con piastre non trattate / Breaking load with no heat treated plates

* Attacchi con misure Dp1, m, n diverse da quelle indicate possono essere forniti su richiesta / On request, attachments with different dimensions Dp1, m, n can be supplied

ATTACCHI PER CATENE TRASPORTO - SERIE 12, 31 E SPECIALE

ATTACHMENTS FOR CONVEYOR CHAINS - 12, 31 AND SPECIAL SERIES

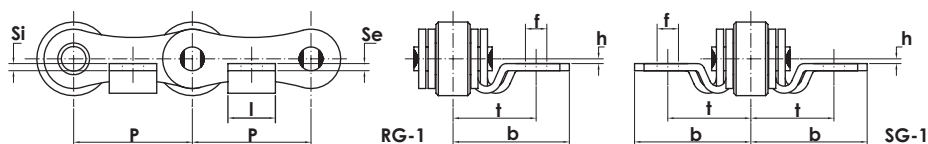

TIPO RG-1 SG-1 - TYPE RG-1 SG-1

CODICE CATENA	passo p mm	Dimensioni							Sovrappeso unitario approssimato attacco	
		altezza aletta h mm	lunghezza aletta l mm	diam. foro aletta f mm	interasse trasversale fori t mm	ingombro trasversale aletta b mm	spessore esterne S _e mm	spessore interne S _i mm	RG-1 Kg	SG-1 Kg
• 3127/50	50	2,0	20	6,5	35	49	3,0	3,0	0,019	0,037

* Possibile fornitura con foro aletta f=9 / Available also f=9

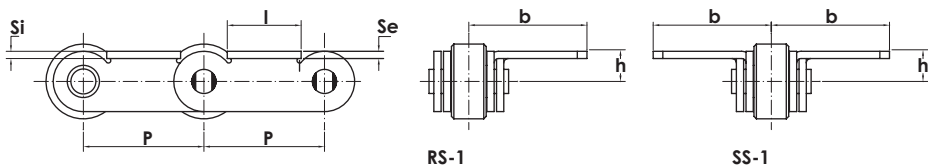

TIPO RS-1 SS-1 - TYPE RS-1 SS-1

CODICE CATENA	passo p mm	Dimensioni					Sovrappeso unitario approssimato attacco	
		altezza aletta h mm	lunghezza aletta l mm	ingombro trasversale aletta b mm	spessore esterne S _e mm	spessore interne S _i mm	RS-1 Kg	SS-1 Kg
• 3127/50	50	12,5	30	44,5	3,0	3,0	0,025	0,049

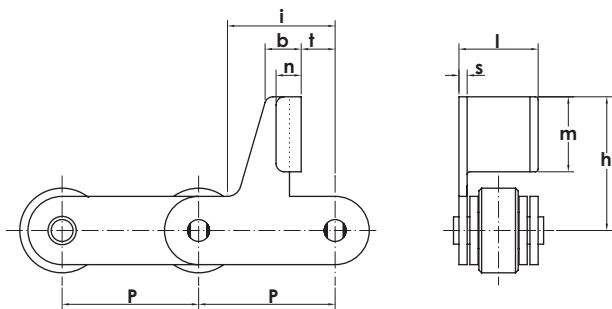

TIPO EC - TYPE EC

CODICE CATENA	passo p mm	Dimensioni								Sovrappeso unitario approssimato attacco EC Kg
		altezza aletta h mm	lunghezza aletta l mm	altezza bandiera m mm	lunghezza ricciolo n mm	posizione base attacco i mm	posizione vertice attacco t mm	lunghezza attacco b mm	spessore attacco s mm	
• 3142/63	63,5	55	33	35	10,0	47	15	15	4,0	0,076
• 3142/75	75,0	55	33	35	10,0	49	19	15	4,0	0,060

CATENE TRASPORTO SERIE EUROPEA (ISO 1977 - DIN 8167)

CONVEYOR CHAINS EUROPEAN STANDARD (ISO 1977 - DIN 8167)

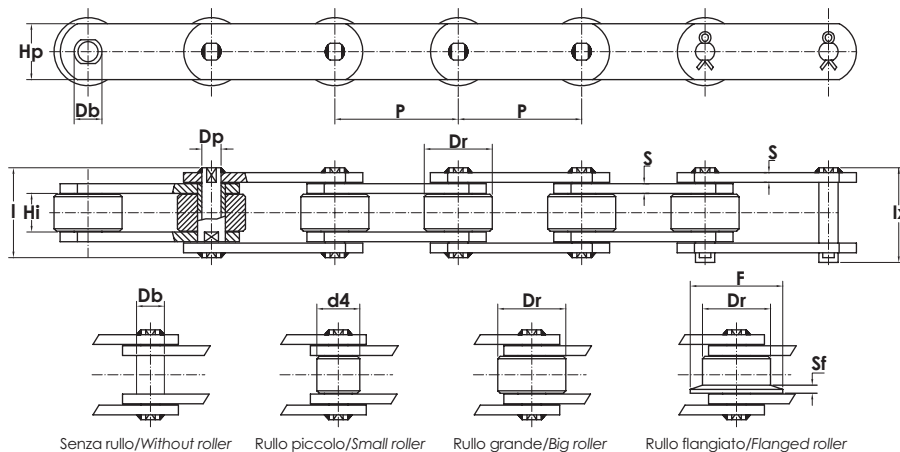

PERNI PIENI - SOLID PINS

CODICE CATENA	Dimensioni nominali				Altre dimensioni								Carico minimo di rottura		Peso netto al m. Kg/m	TRADE MARK
	passo	largh. interna min.	diam. rullo	altezza max piastra	spess. piastre	diam. rullo piccolo	diam. flangia	spess. flangia	diam. max perno	diam. bussola	largh. perno ribad	ingombro max	N Kg	T* Kg		
	p mm	Hi mm	Dr mm	Hp mm	S mm	d4 mm	F mm	Sf mm	Dp mm	Db mm	I mm	Ix mm	N Kg	T* Kg		
<ul style="list-style-type: none"> • M20-P-40 • M20-P-50 • M20-P-63 • M20-P-80 	40 50 63 80	16	25	18	2,5	12,5	30	3,5	6,0	9,00	32	36	2.040	3.200	2,50 2,18 1,89 1,66	EURO CATENE
<ul style="list-style-type: none"> • M28-P-50 • M28-P-63 • M28-P-80 • M28-P-100 	50 63 80 100	18	30	20	3,0	15,0	36	4,0	7,0	10,00	36	40	2.850	4.250	3,05 2,65 2,29 2,02	
<ul style="list-style-type: none"> • M40-P-63 • M40-P-80 • M40-P-100 • M40-P-125 • M40-P-160 	63 80 100 125 160	20	36	25	4,0	18,0	45	4,5	8,5	12,50	42	45	4.070	6.000	4,41 3,87 3,30 2,98 2,54	
<ul style="list-style-type: none"> • M56-P-63 • M56-P-80 • M56-P-100 • M56-P-125 • M56-P-160 • M56-P-200 • M56-P-250 	63 80 100 125 160 200 250	24	42	30	4,0	21,0	50	5,0	10,0	15,00	48	52	5.710	8.900	6,40 5,53 4,80 4,22 3,71 3,34 3,05	
<ul style="list-style-type: none"> • M80-P-80 • M80-P-100 • M80-P-125 • M80-P-160 • M80-P-200 • M80-P-250 	80 100 125 160 200 250	28	50	35	5,0	25,0	60	6,0	12,0	18,00	55	58	8.155	11.800	8,87 7,94 6,95 6,00 5,35 4,68	

* T Carico di rottura per catene con piastre trattate / Breaking load with heat treated plates

CATENE TRASPORTO SERIE EUROPEA (ISO 1977 - DIN 8167)

CONVEYOR CHAINS EUROPEAN STANDARD (ISO 1977 - DIN 8167)

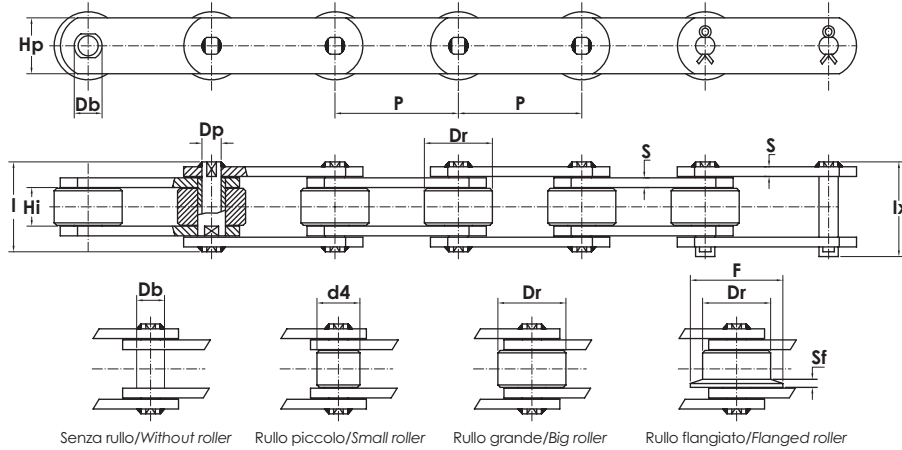

PERNI PIENI - SOLID PINS

CODICE CATENA	Dimensioni nominali			Altre dimensioni									Carico minimo di rottura		Peso netto al m. Kg/m	TRADE MARK
	passo	largh. interna min.	diam. rullo	altezza max piastra	spess. piastre	diam. rullo piccolo	diam. flangia	spess. flangia	diam. max perno	diam. bussola	largh. perno ribad	ingombro max	N	T*		
	p mm	Hi mm	Dr mm	Hp mm	S mm	d4 mm	F mm	Sf mm	Dp mm	Db mm	I mm	Ix mm	N Kg	T* Kg		
<ul style="list-style-type: none"> M112-P-80 M112-P-100 M112-P-125 M112-P-160 M112-P-200 M112-P-250 	80 100 125 160 200 250	32	60	40	6	30	70	7,0	15	21,00	63	68	11.417	17.000	13,50 11,73 10,14 9,10 8,10 7,30	EURO CATENE
<ul style="list-style-type: none"> M160-P-100 M160-P-125 M160-P-160 M160-P-200 M160-P-250 M160-P-315 	100 125 160 200 250 315	37	70	50	7	36	85	8,5	18	25,00	74	78	16.310	25.000	18,10 15,83 14,00 12,36 11,00 9,80	
<ul style="list-style-type: none"> M224-P-125 M224-P-160 M224-P-200 M224-P-250 M224-P-315 	125 160 200 250 315	43	85	60	8	42	100	10,0	21	30,00	84	89	22.834	32.000	21,33 18,57 16,40 14,55	
<ul style="list-style-type: none"> M315-P-160 M315-P-200 M315-P-250 M315-P-315 M315-P-400 	160 200 250 315 400	48	100	70	10	50	120	12,0	25	36,00	98	103	32.110	51.000	33,50 28,41 25,72 22,60 20,40	
<ul style="list-style-type: none"> M450-P-200 M450-P-250 M450-P-315 M450-P-400 	200 250 315 400	56	120	80	12	60	140	15,5	30	42,00	114	124	45.870	71.000	40,5 39,5 34,5 30,5	

* T Carico di rottura per catene con piastre trattate / Breaking load with heat treated plates

CATENE TRASPORTO A PERNO FORATO - SERIE EUROPEA (ISO 1977 - DIN 8168)

HOLLOW PIN CONVEYOR CHAINS - EUROPEAN STANDARD (ISO 1977 - DIN 8168)

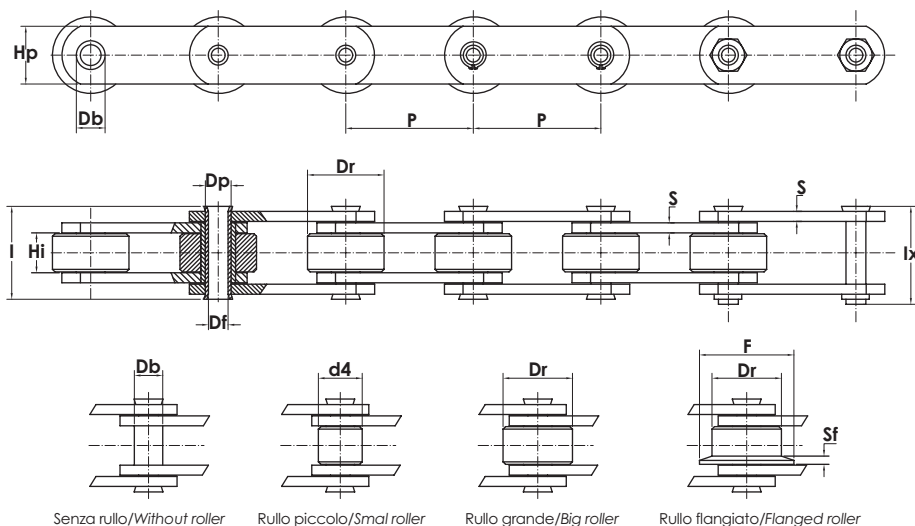

PERNI FORATI - HOLLOW PINS

CODICE CATENA	Dimensioni nominali				Altre dimensioni									Carico minimo di rottura		Peso netto al m.	TRADE MARK
	passo	largh. interna min.	diam. rullo	altezza max piastra	spess. piastre	diam. rullo piccolo	diam. flangia	spess. flangia	diam. max perno	diam. foro perno	diam. bussola	largh. perno ribad.	ingombro max	N Kg	T* Kg		
	p mm	Hi mm	Dr mm	Hp mm	S mm	d4 mm	F mm	Sf mm	Dp mm	Df mm	Db mm	l mm	lx mm	N Kg	T* Kg		
<ul style="list-style-type: none"> MC28-P-63 MC28-P-80 MC28-P-100 MC28-P-125 	63 80 100 125	20	36	25	4,0	25	45	4,5	13,0	8,2	17	42	45	2.850	4.400	3,90 3,50 3,05 2,75	
<ul style="list-style-type: none"> MC56-P-80 MC56-P-100 MC56-P-125 MC56-P-160 	80 100 125 160	24	50	35	4,0	30	60	5,0	15,5	10,2	21	46	48	5.710	8.400	6,78 5,86 5,13 4,49	
<ul style="list-style-type: none"> MC112-P-100 MC112-P-125 MC112-P-160 MC112-P-200 MC112-P-250 	100 125 160 200 250	32	70	50	6,0	42	85	7,0	22,0	14,2	30	64	67	11.417	17.000	14,80 12,76 11,00 9,75 8,74	
<ul style="list-style-type: none"> MC224-P-160 MC224-P-200 MC224-P-250 MC224-P-315 MC224-P-400 MC224-P-500 	160 200 250 315 400 500	43	100	70	8,0	60	120	10,0	30	20,3	42	84	87	22.834	34.000	25,99 25,56 19,80 17,52 15,67 14,30	

EURO
CATENE

ATTACCHI PER CATENE TRASPORTO - SERIE EUROPEA (ISO 1977 - DIN 8167)

ATTACHMENTS FOR CONVEYOR CHAINS - EUROPEAN STANDARD (ISO 1977 - DIN 8167)

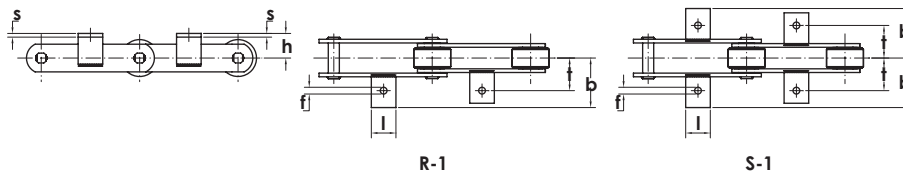

R-1

S-1

TIPO R-1 S-1 - TYPE R-1S-1

CODICE CATENA	Passo minimo di applicabilità alle piastre	Dimensioni						Sovrappeso unitario approssimato attacco	
		altezza aletta	lunghezza aletta	diam. fori aletta	interasse trasvers. fori	ingombro trasvers. aletta	spessore aletta	R-1 Kg	S-1 Kg
		h mm	l mm	f mm	t mm	b mm	s mm		
• M20	40	16	20	6,5	27	40	3	0,023	0,045
• M28	50	20	20	9	32	48	3	0,035	0,070
• M40	63	25	25	9	35	56	3	0,044	0,088
• M56	63	30	25	11	44	60	4	0,063	0,126
• M80	80	35	30	11	48	65	4	0,118	0,236
• M112	80	40	40	14	55	80	5:6	0,195	0,390
• M160	100	45	40	14	62	85	6	0,332	0,664
• M224	125	55	50	18	70	100	8	0,445	0,890
• M315	160	65	50	18	80	115	9	0,665	1,330
• M450	200	75	50	18	90	135	10	0,750	1,500
• MC28	63	25	20	9	35	56	3	0,044	0,088
• MC56	80	35	25	11	44	76	4	0,075	0,150
• MC112	100	45	40	14	55	96	5	0,265	0,530
• MC224	160	65	50	18	70	110	6	0,520	1,040

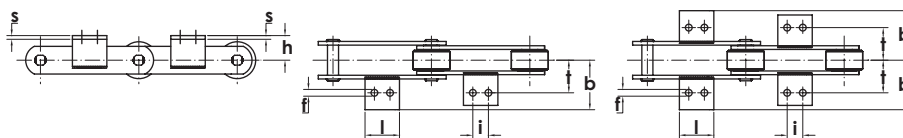

R-24

S-24

TIPO R-24 S-24 - TYPE R-24 S-24

CODICE CATENA	Passo minimo di applicabilità alle piastre	Dimensioni							Sovrappeso unitario approssimato attacco	
		altezza aletta	lunghezza aletta	diam. fori aletta	interasse trasvers. fori	ingombro trasvers. aletta	interasse longitud. aletta	spessore aletta	R-24 Kg	S-24 Kg
		h mm	l mm	f mm	t mm	b mm	i mm	s mm		
• M20	63	16	35	6,5	27	40	20	3	0,034	0,068
• M28	80	20	45	9	32	48	25	3	0,056	0,112
• M40	80	25	40	9	35	56	20	3	0,070	0,140
• M56	100	30	50	11	44	60	25	4	0,116	0,231
• M80	125	35	75	11	48	65	50	4	0,237	0,474
• M112	125	40	65	14	55	80	35	5:6	0,339	0,678
• M160	125	45	80	14	62	85	50	6	0,510	1,020
• M224	200	55	100	18	70	100	65	8	0,820	1,640
• M315	200	65	85	18	80	115	50	9	0,998	1,996
• M450	200	75	125	18	90	135	85	10	1,450	2,900
• MC28	80	25	40	9	35	56	20	3	0,070	0,140
• MC56	125	35	75	11	44	76	50	4	0,150	0,300
• MC112	160	45	80	14	55	96	50	5	0,440	0,880
• MC224	200	65	85	18	70	110	50	6	0,715	1,430

ATTACCHI PER CATENE TRASPORTO - SERIE EUROPEA (ISO 1977 - DIN 8167)

ATTACHMENTS FOR CONVEYOR CHAINS - EUROPEAN STANDARD (ISO 1977 - DIN 8167)

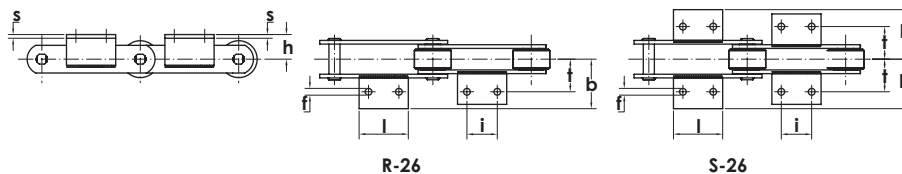

R-26

S-26

TIPO R-26 S-26 - TYPE R-26 S-26

CODICE CATENA	Passo minimo di applicabilità alle piastre	Dimensioni							Sovrappeso unitario approssimato attacco	
		altezza aletta	lunghezza aletta	diam. fori aletta	interasse trasvers. fori	ingombro trasvers. aletta	interasse longitud. aletta	spessore aletta	R-26 Kg	S-26 Kg
		h mm	l mm	f mm	t mm	b mm	i mm	s mm		
• M20	80	16	45	6,5	27	40	30	3	0,051	0,101
• M28	100	20	55	9	32	48	35	3	0,077	0,154
• M40	100	25	60	9	35	56	40	3	0,110	0,220
• M56	125	30	80	11	44	60	55	4	0,168	0,336
• M80	160	35	110	11	48	65	85	4	0,370	0,740
• M112	160	40	100	14	55	80	65	5:6	0,485	0,970
• M160	200	45	120	14	62	85	85	6	0,790	1,580
• M224	250	55	170	18	70	100	125	8	1,265	2,530
• M315	250	65	140	18	80	115	100	9	1,555	3,110
• M450	315	75	195	18	90	135	155	10	2,250	4,500
• MC28	100	25	60	9	35	56	40	3	0,110	0,220
• MC56	160	35	110	11	44	76	85	4	0,241	0,482
• MC112	200	45	120	14	55	96	85	5	0,635	1,270
• MC224	250	65	140	18	70	110	100	6	1,076	2,152

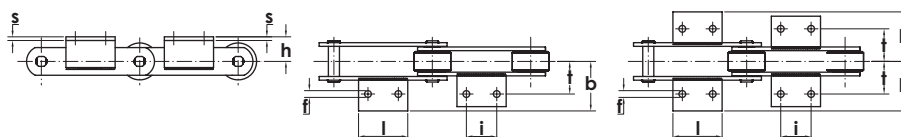

R-28

S-28

TIPO R-28 S-28 - TYPE R-28 S-28

CODICE CATENA	Passo minimo di applicabilità alle piastre	Dimensioni							Sovrappeso unitario approssimato attacco	
		altezza aletta	lunghezza aletta	diam. fori aletta	interasse trasvers. fori	ingombro trasvers. aletta	interasse longitud. aletta	spessore aletta	R-28 Kg	S-28 Kg
		h mm	l mm	f mm	t mm	b mm	i mm	s mm		
• M20	100	16	65	6,5	27	40	50	3	0,073	0,146
• M28	125	20	80	9	32	48	60	3	0,112	0,224
• M40	125	25	85	9	35	56	65	3	0,150	0,300
• M56	160	30	115	11	44	60	90	4	0,242	0,483
• M80	200	35	150	11	48	65	125	4	0,502	1,004
• M112	200	40	140	14	55	80	100	5:6	0,680	1,360
• M160	250	45	180	14	62	85	145	6	1,185	2,370
• M224	315	55	230	18	70	100	190	8	1,910	3,820
• M315	315	65	200	18	80	115	155	9	2,225	4,450
• M450	400	75	280	18	90	135	240	10	3,250	6,500
• MC28	125	25	85	9	35	56	65	3	0,150	0,300
• MC56	200	35	150	11	44	76	125	4	0,330	0,660
• MC112	250	45	180	14	55	96	145	5	0,953	1,906
• MC224	315	65	200	18	70	110	155	6	1,590	3,180

ATTACCHI PER CATENE TRASPORTO - SERIE EUROPEA (ISO 1977 - DIN 8167)

ATTACHMENTS FOR CONVEYOR CHAINS - EUROPEAN STANDARD (ISO 1977 - DIN 8167)

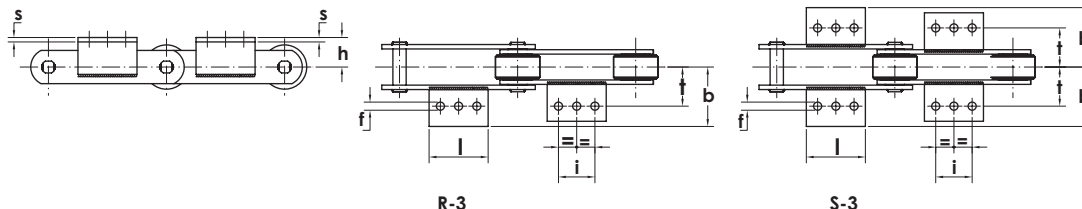

TIPO R-3 S-3 - TYPE R-3 S-3

CODICE CATENA	Passo minimo di applicabilità alle piastre	Dimensioni							Sovrappeso unitario approssimato attacco	
		altezza aletta	lunghezza aletta	diam. fori aletta	interasse trasvers. fori	ingombro trasvers. aletta	interasse longitud. aletta	spessore aletta	R-3 Kg	S-3 Kg
		h mm	l mm	f mm	t mm	b mm	i mm	s mm		
• M20	80	16	45	6,5	27	40	30	3	0,051	0,101
• M28	100	25	55	9	32	48	35	3	0,077	0,154
• M40	100	25	60	9	35	56	40	3	0,110	0,220
• M56	125	30	80	11	44	60	55	4	0,168	0,336
• M80	160	35	110	11	48	65	85	4	0,370	0,740
• M112	160	40	100	14	55	80	65	5:6	0,485	0,970
• M160	200	45	120	14	62	85	85	6	0,790	1,580
• M224	250	55	170	18	70	100	125	8	1,265	2,530
• M315	250	65	140	18	80	115	100	9	1,555	3,110
• MC28	100	25	60	9	35	56	40	3	0,110	0,220
• MC56	160	35	110	11	44	76	85	4	0,241	0,482
• MC112	200	45	120	14	55	96	85	5	0,635	1,270
• MC224	250	65	140	18	70	110	100	6	1,076	2,152

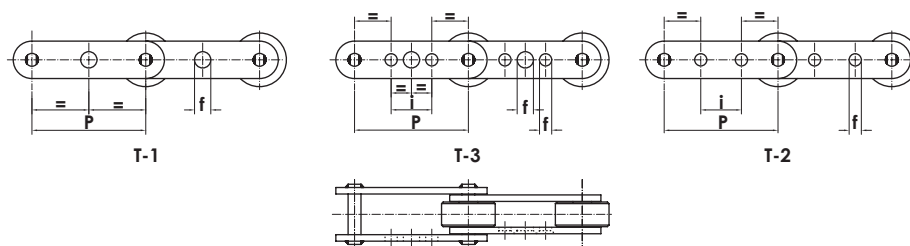

PERNI PIENI - SOLID PINS

TIPO T-1 T-2 T-3 - TYPE T-1 T-2 T-3

CODICE CATENA	Passo minimo di applicabilità per T-2 T-3	Dimensioni		
		diam. foro centrale	diam. fori laterali	interasse fori laterali
		f mm	f ₁ mm	i Kg
• M20	100	7	6	50
• M28	125	9	7	58
• M40	160	11	9	63
• M56	160	12	10	70
• M80	200	15	11	80
• M112	200	15	14	80
• M160	250	21	14	100
• M224	250	21	18	100
• M315	315	25	18	125

PERNI FORATI - HOLLOW PINS

TIPO T-1 T-2 T-3 - TYPE T-1 T-2 T-3

CODICE CATENA	Passo minimo di applicabilità per T-2 T-3	Dimensioni		
		diam. foro centrale	diam. fori laterali	interasse fori laterali
		f mm	f ₁ mm	i Kg
• MC28	125	9	9	63
• MC56	160	11	11	80
• MC112	200	15	14	100
• MC224	315	21	18	125

CATENE TRASPORTO PIASTRE RIALZATE SERIE EUROPEA (ISO 1977 - DIN 8167)

DEEP LINK CONVEYOR CHAINS EUROPEAN STANDARD (ISO 1977 - DIN 8167)

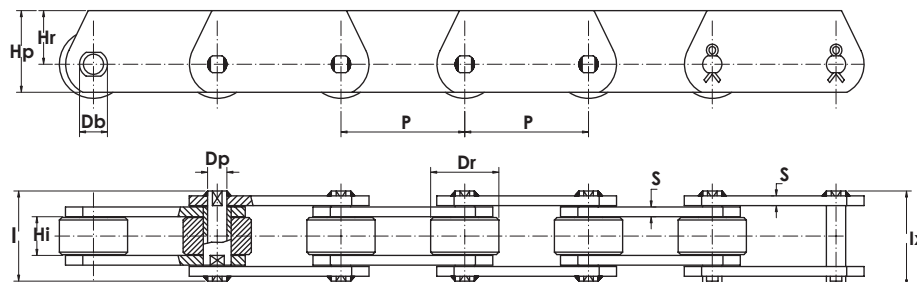

PERNI PIENI - SOLID PINS

CODICE CATENA	Dimensioni nominali			Altre dimensioni							Carico minimo di rottura		TRADE MARK
	passo	largh. interna min.	diam. rullo	altezza max piastra	altezza rialzo	spess. piastre	diam. max perno	diam. bussola	largh. perno ribad	ingombro max	N Kg	T* Kg	
	p mm	H _i mm	D _r mm	H _p mm	H _r mm	S mm	D _p mm	D _b mm	I mm	I _x mm			
• ME40	63	20	36	35	22,5	4	8,5	12,5	42	45	4.070	6.000	EURO CATENE
	80												
	100												
	125												
• ME56	63	24	42	45	30,0	4	10,0	15,0	48	52	5.710	8.900	
	80												
	100												
	125												
	200												
• ME80	80	28	50	50	32,5	5	12,0	18,0	55	58	8.155	11.800	
	100												
	125												
	160												
	200												
	250												
• ME112	80	32	60	60	40	6	15,0	21,0	63	68	11.417	17.000	
	100												
	125												
	160												
	200												
	250												

* T Carico di rottura per catene con piastre trattate / Breaking load with heat treated plates

CATENE TRASPORTO PIASTRE RIALZATE SERIE EUROPEA (ISO 1977 - DIN 8167)

DEEP LINK CONVEYOR CHAINS EUROPEAN STANDARD (ISO 1977 - DIN 8167)

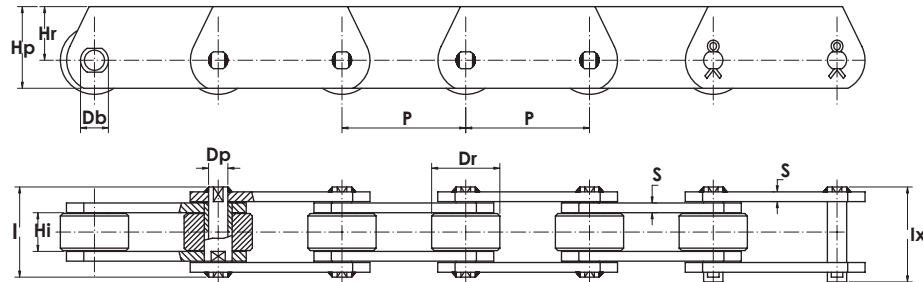

PERNI PIENI - SOLID PINS

CODICE CATENA	Dimensioni nominali			Altre dimensioni							Carico minimo di rottura		TRADE MARK
	passo	largh. interna min.	diam. rullo	altezza max piastra	altezza rialzo	spess. piastre	diam. max perno	diam. bussola	largh. perno ribad	ingombro max	N	T*	
	p mm	H _i mm	D _r mm	H _p mm	H _r mm	S mm	D _p mm	D _b mm	I mm	I _x mm	Kg	Kg	
• ME160	100												
	125												
	160	37	70	70	45,0	6 ext 8 int	18	25,0	74	78	16.310	25.000	
	200												
	250												
• ME224	315												
	125												
	160												
	200	43	85	90	60,0	8	21	30,0	84	89	22.834	32.000	
• ME315	250												
	315												
	250	48	100	100	65,0	10	25	36,0	98	103	32.110	51.000	
	315												
	400												
• ME450	200												
	250												
	315	56	120	120	80,0	12	30	42,0	114	124	45.870	71.000	
	400												

**EURO
CATENE**

* T Carico di rottura per catene con piastre trattate / Breaking load with heat treated plates

CATENE TRASPORTO SERIE FV (DIN 8165)

CONVEYOR CHAINS (DIN 8165)

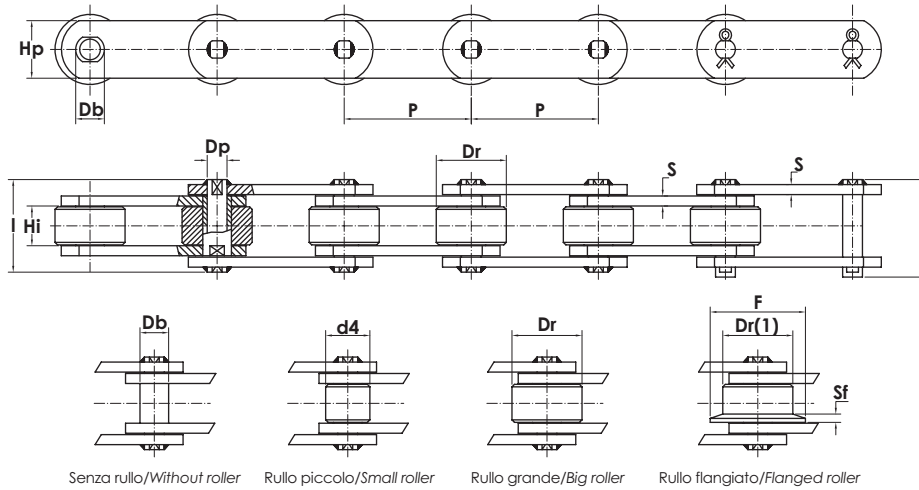

Senza rullo/Without roller Rullo piccolo/Small roller Rullo grande/Big roller Rullo flangiato/Flanged roller

PERNI PIENI - SOLID PINS

CODICE CATENA	Dimensioni nominali			Altre dimensioni									Carico minimo di rottura		Peso netto al m. Kg/m	TRADE MARK
	passo	largh. interna min.	diam. rullo	altezza max piastra	spess. piastre	diam. rullo piccolo	diam. rullo flangiato	spess. flangia	diam. max perno	diam. bussola	largh. perno ribad	ingombro max	N Kg	T* Kg		
	p mm	H _i mm	D _r mm	H _p mm	S mm	d ₄ mm	Dr(1)/F mm	S _f mm	D _p mm	D _b mm	l mm	l _x mm	N Kg	T* Kg		
<ul style="list-style-type: none"> FV40-P-50 FV40-P-63 FV40-P-80 FV40-P-100 FV40-P-125 	50 63 80 100 125	18	32	25	3	20	40/50	4,5	10	15	36	39	4.070	4.800	4,00 3,30 3,00 2,60 2,30	EURO CATENE
<ul style="list-style-type: none"> FV63-P-63 FV63-P-80 FV63-P-100 FV63-P-125 FV63-P-160 	63 80 100 125 160	22	40	30	4	26	50/60	5,50	12	18	45	48	6.420	8.000	6,40 5,30 4,70 4,00 3,50	
<ul style="list-style-type: none"> FV90-P-80 FV90-P-100 FV90-P-125 FV90-P-160 FV90-P-200 	80 100 125 160 200	25	48	35	5	30	63/75	5,50	14	20	53	57	9.174	12.000	8,60 7,30 6,50 5,80 4,80	
<ul style="list-style-type: none"> FV112-P-80 FV112-P-100 FV112-P-125 FV112-P-160 FV112-P-200 FV112-P-250 	80 100 125 160 200 250	30	55	40	6	32	72/90	7,00	16	22	62	67	11.417	17.000	12,90 11,20 9,60 8,30 7,50 6,70	

CATENE TRASPORTO SERIE FV (DIN 8165)

CONVEYOR CHAINS (DIN 8165)

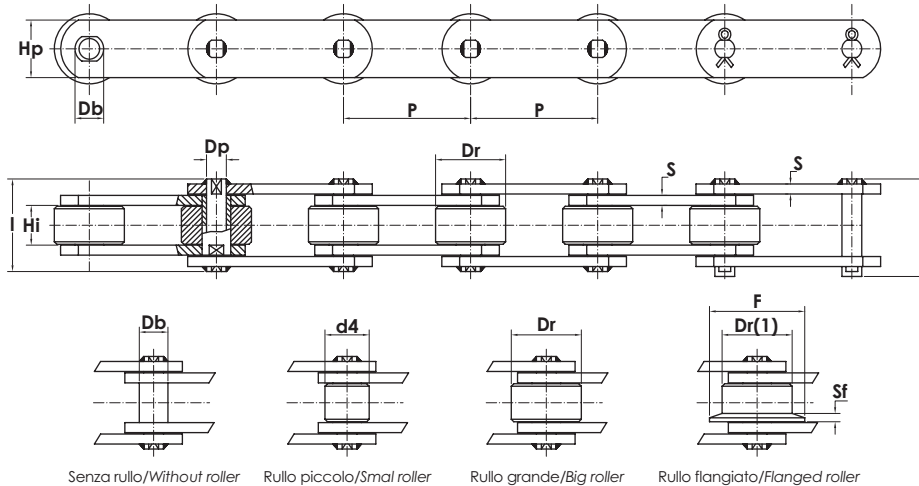

PERNI PIENI - SOLID PINS

CODICE CATENA	Dimensioni nominali				Altre dimensioni									Carico minimo di rottura		Peso netto al m. Kg/m	TRADE MARK
	passo	largh. interna min.	diam. rullo	altezza max piastra	spess. piastre	diam. rullo piccolo	diam. rullo flangiato	spess. flangia	diam. max perno	diam. bussola	largh. perno ribad	ingombro max	N Kg	T* Kg			
	p mm	Hi mm	Dr mm	Hp mm	S mm	d4 mm	Dr(1)/F mm	Sf mm	Dp mm	Db mm	I mm	lx mm	N Kg	T* Kg			
<ul style="list-style-type: none"> FV140-P-100 FV140-P-125 FV140-P-160 FV140-P-200 FV140-P-250 	100 125 160 200 250	35	60	45	6	36	80/95	7,00	18	26	67	71	14.270	20.387	14,330 12,30 10,50 9,00 8,30	EURO CATENE	
<ul style="list-style-type: none"> FV180-P-125 FV180-P-160 FV180-P-200 FV180-P-250 FV180-P-315 	125 160 200 250 315	45	70	50	8	42	100/120	8,00	20	30	86	90	18.348	25.500	18,90 16,70 14,80 13,00 11,60		
<ul style="list-style-type: none"> FV250-P-160 FV250-P-200 FV250-P-250 FV250-P-315 	160 200 250 315	55	80	60	8	50	125/150	11,00	26	36	97	103	25.484	32.000	23,80 20,60 17,90 15,80		
<ul style="list-style-type: none"> FV315-P-160 FV315-P-200 FV315-P-250 FV315-P-315 	160 200 250 315	65	90	70	10	60	140/175	13,00	30	42	112	125	32.110	48.000	33,30 28,90 25,30 22,40		
<ul style="list-style-type: none"> FV400-P-200 FV400-P-250 FV400-P-315 FV400-P-400 	200 250 315 400	70	100	70	12	60	150/185	13,00	32	44	130	145	40.775	-	39,00 34,00 30,00 27,00		

* T Carico di rottura per catene con piastre trattate / Breaking load with heat treated plates

ATTACCHI PER CATENE TRASPORTO - SERIE FV (DIN 8165)

ATTACHMENTS FOR CONVEYOR CHAINS (DIN 8165)

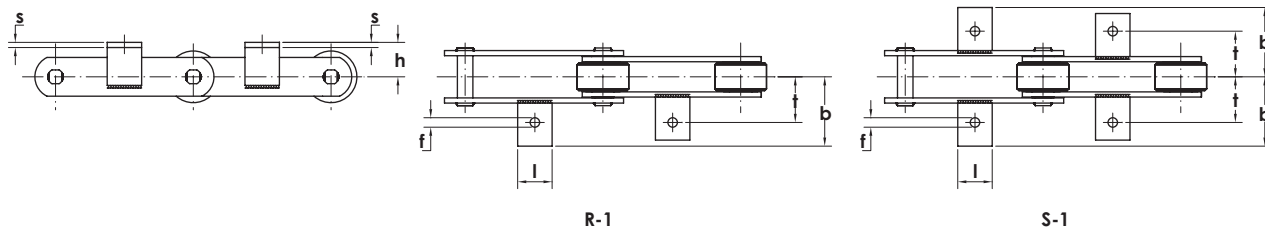

R-1

S-1

TIPO R-1 S-1 - TYPE R-1 S-1

CODICE CATENA	Passo minimo di applicabilità alle piastre	Dimensioni						Sovrappeso unitario approssimato attacco	
		altezza aletta	lunghezza aletta	diam. fori aletta	interasse trasvers. fori	ingombro trasvers. aletta	spessore aletta	R-1 Kg	S-1 Kg
		h mm	l mm	f mm	t mm	b mm	s mm		
• FV40	50	20	25	6,50	25	45	3	0,04	0,08
• FV63	63	30	30	9,0	34	50	4	0,05	0,100
• FV90	80	35	35	9,0	40	65	4	0,085	0,170
• FV112	100	40	50	11,0	50	70	5	0,150	0,300
• FV140	100	45	50	11,0	50	81	5	0,180	0,360
• FV180	125	45	60	14,0	64	90	6	0,215	0,430
• FV250	160	55	80	14,0	69	110	8	0,550	1,100
• FV315	160	60	80	14,0	85	125	8	0,700	1,400
• FV400	160	65	80	18,0	95	145	10	1,000	2,000

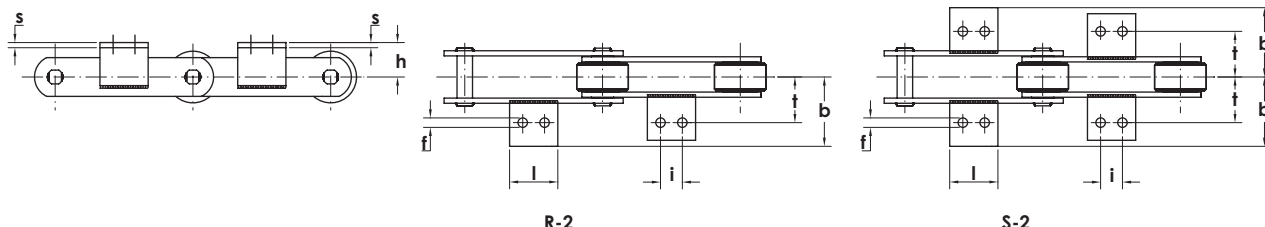

R-2

S-2

TIPO R-2 S-2 - TYPE R-2 S-2

CODICE CATENA	Passo minimo di applicabilità alle piastre	Dimensioni							Sovrappeso unitario approssimato attacco	
		altezza aletta	lunghezza aletta	diam. fori aletta	interasse trasvers. fori	ingombro trasvers. aletta	interasse longitud. aletta	spessore aletta	R-2 Kg	S-2 Kg
		h mm	l mm	f mm	t mm	b mm	i mm	s mm		
• FV40	100	20	50	6,5	25	45	30	3	0,050	0,100
• FV63	100	30	50	9,0	34	50	30	4	0,090	0,180
• FV90	100	35	50	9,0	40	65	30	4	0,120	0,240
• FV112	100	40	50	11,0	50	70	30	5	0,140	0,280
• FV140	100	45	55	11,0	50	81	30	5	0,200	0,400
• FV180	125	45	65	14,0	64	90	35	6	0,290	0,580
• FV250	160	55	80	14,0	69	110	50	8	0,600	1,200
• FV315	200	60	95	14,0	85	125	65	8	0,800	1,600
• FV400	200	65	100	18,0	95	145	60	10	1,250	2,500

CATENE TRASPORTO A PERNO FORATO SERIE FV (DIN 8165)

HOLLOW PIN CONVEYOR CHAINS (DIN 8165)

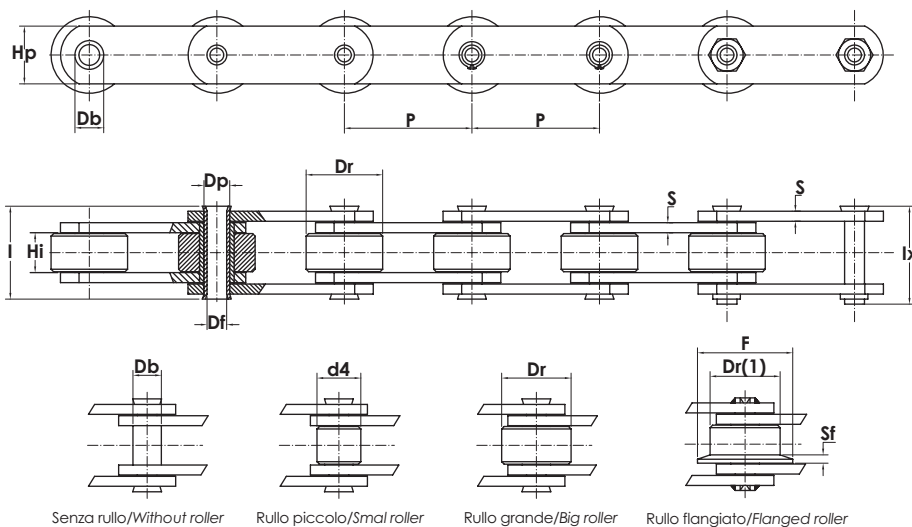

PERNI FORATI- HOLLOW PIN

CODICE CATENA	Dimensioni nominali				Altre dimensioni									Carico minimo di rottura N Kg	TRADE MARK
	passo	largh. interna min.	diam. rullo	altezza max piastra	spess. piastre	diam. rullo piccolo	diam. rullo flangiato	spess. flangia	diam. est. perno	diam. foro perno	diam. bussola	largh. perno ribad	ingombro max		
	p mm	Hi mm	Dr mm	Hp mm	S mm	d4 mm	Dr(1)/F mm	Sf mm	Dp mm	Df mm	Db mm	l mm	lx mm		
• FV63 PF	63	22	40	30	4	26	50/60	5,50	12	8	18	45	48	4.600	
	80														
	100														
	125														
	160														
• FV90 PF	80	25	48	35	5	30	63/75	5,50	14	10	20	53	57	7.300	
	100														
	125														
	160														
	200														
• FV112 PF	100	30	55	40	6	32	72/90	7,00	16	10	22	62	67	9.000	
	125														
	160														
	200														
	250														
• FV140 PF	100	35	60	45	6	36	80/95	8,00	18	12	26	67	71	11.000	
	125														
	160														
	200														
	250														

**EURO
CATENE**

CATENE TRASPORTO A PERNO FORATO SERIE FV (DIN 8165)

HOLLOW PIN CONVEYOR CHAINS (DIN 8165)

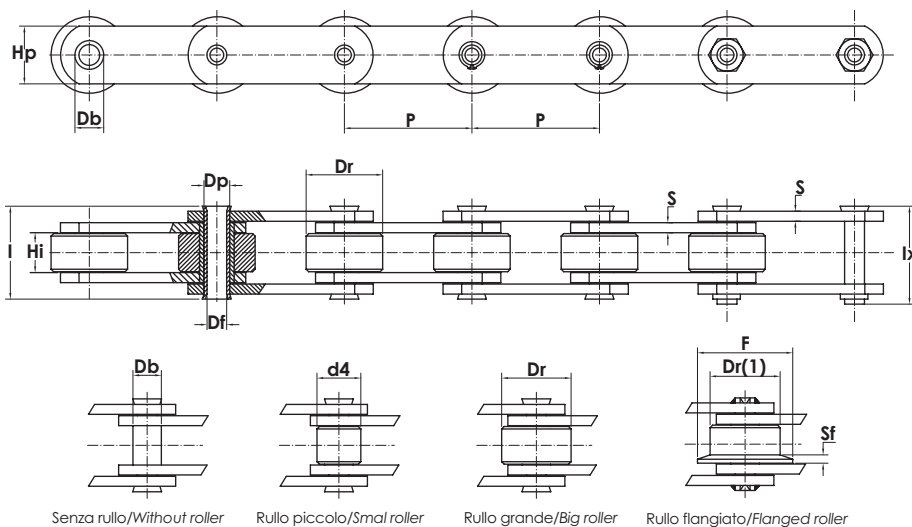

PERNI FORATI- HOLLOW PIN

CODICE CATENA	Dimensioni nominali			Altre dimensioni										Carico minimo di rottura N Kg	TRADE MARK		
	passo	largh. interna min.	diam. rullo	altezza max piastra	spess. piastre	diam. rullo piccolo	diam. rullo flangiato	spess. flangia	diam. est. perno	diam. foro perno	diam. bussola	largh. perno ribad	ingombro max				
	p mm	Hi mm	Dr mm	Hp mm	S mm	d4 mm	Dr(1)/F mm	Sf mm	Dp mm	Df mm	Db mm	l mm	lx mm				
• FV180 PF	125														14.500	EURO CATENE	
	160													90			
	200	45	70	50	8	42	100/120	9	20	14	30	86	103				
	250																21.500
• FV250 PF	315													103	21.500		
	160																103
	200	55	80	60	8	50	125/150	15	26	18	36	97	120				
• FV315 PF	250														29.500		29.500
	315	65	90	70	10	60	140/175	20	30	20	42	115	120				
	400													120			

CATENE TRASPORTO A PIASTRE RIALZATE SERIE FV (DIN 8165)

DEEP LINK CONVEYOR CHAINS (DIN 8165)

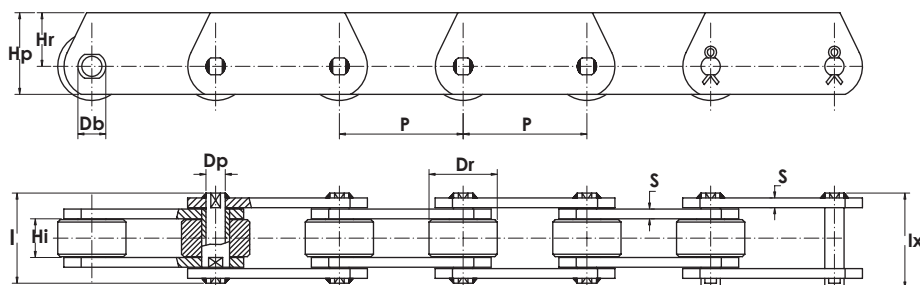

PERNI PIENI - SOLID PINS

CODICE CATENA	Dimensioni nominali			Altre dimensioni							Carico minimo di rottura		TRADE MARK
	passo	largh. interna min.	diam. rullo	altezza max piastra	altezza rialzo	spess. piastre	diam. max perno	diam. bussola	largh. perno ribad	ingombro max	N Kg	T+ Kg	
	p mm	Hi mm	Dr mm	Hp mm	Hr mm	S mm	Dp mm	Db mm	I mm	Ix mm			
• FVT40	50	18	32	35	22,5	3	10	15	36	39	4.070	4.800	EURO CATENE
	63												
	80												
	100												
	125												
• FVT63	63	22	40	40	25	4	12	18	45	48	6.420	8.000	EURO CATENE
	80												
	100												
	125												
	160												
• FVT90	80	25	48	45	27,5	5	14	20	53	57	9.174	12.000	EURO CATENE
	100												
	125												
	160												
	200												
• FVT112	100	30	55	50	30	6	16	22	62	67	11.417	17.000	EURO CATENE
	125												
	160												
	200												
	250												
• FVT140	100	35	60	60	37,5	6	18	26	67	71	14.270	20.387	EURO CATENE
	125												
	160												
	200												
	250												

* T Carico di rottura per catene con piastre trattate / Breaking load with heat treated plates

CATENE TRASPORTO A PIASTRE RIALZATE SERIE FV (DIN 8165)

DEEP LINK CONVEYOR CHAINS (DIN 8165)

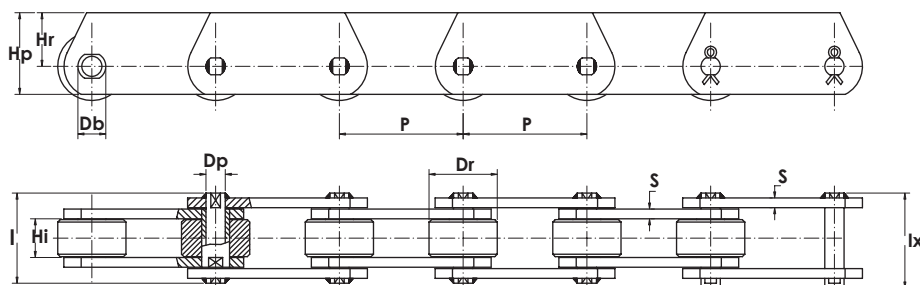

PERNI PIENI - SOLID PINS

CODICE CATENA	Dimensioni nominali			Altre dimensioni							Carico minimo di rottura		TRADE MARK
	passo	largh. interna min.	diam. rullo	altezza max piastra	altezza rialzo	spess. piastre	diam. max perno	diam. bussola	largh. perno ribad	ingombro max	N Kg	T* Kg	
	p mm	H _i mm	D _r mm	H _p mm	H _r mm	S mm	D _p mm	D _b mm	I mm	I _x mm			
• FVT180	125												
	160												
	200	45	70	70	45	8	20	30	86	90	18.348	25.000	
	250												
	315												
• FVT250	160												
	200												
	250	55	80	80	50	8	26	36	97	103	25.484	32.000	
	315												
• FVT315	160												
	200												
	250	65	90	90	55	10	30	42	112	125	32.110	48.000	
	315												
	400												
• FVT400	160												
	200												
	250	70	100	90	55	12	32	44	128	140	40.775	55.000	
	315												
	400												

EURO
CATENE

* T Carico di rottura per catene con piastre trattate / Breaking load with heat treated plates

CATENE TRASPORTO NON UNIFICATE

NON STANDARD CONVEYOR CHAINS

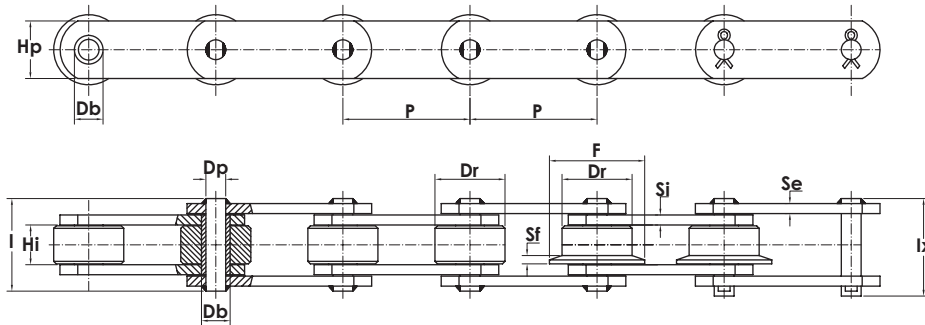

PERNI PIENI RULLI PIANI - SOLID PINS PLAIN ROLLERS

CODICE CATENA	Dimensioni nominali			Altre dimensioni									Carico minimo di rottura		Peso netto al m. Kg/m	TRADE MARK
	passo	largh. interna min.	diam. rullo	altezza max piastra	spess. piastre int.	spess. piastre est.	diam. max perno	diam. bussola	diam. flangia	spess. flangia	largh. perno ribad	ingombro max	N Kg	T* Kg		
	P mm	Hi mm	Dr mm	Hp mm	Si mm	Se mm	Dp mm	Db mm	F mm	Sf mm	I mm	Ix mm				
<ul style="list-style-type: none"> • NU17/381 • NU17/508 ♦ NU17/635 • NU17/762 ♦ NU17/889 ♦ NU17/1016 ♦ NU17/1143 	38,1 50,8 63,5 76,2 88,9 101,6 114,3	11,70	12,07	18	2,5	2,5	5,70	8,05	-	-	26,0	30	-	3.800	1,23 1,09 1,01 0,96 0,92 0,89 0,86	EURO CATENE
<ul style="list-style-type: none"> • NU18/381 • NU18/508 ♦ NU18/635 • NU18/762 ♦ NU18/889 ♦ NU18/1016 ♦ NU18/1143 	38,1 50,8 63,5 76,2 88,9 101,6 114,3	11,70	25,40	18	2,5	2,5	5,70	8,05	-	-	26,0	30	-	3.800	2,16 1,79 1,57 1,43 1,32 1,24 1,17	
<ul style="list-style-type: none"> • NU28/508 • NU28/635 • NU28/762 • NU28/889 • NU28/1016 • NU28/1143 • NU28/1270 • NU28/1397 • NU28/1524 	50,8 63,5 76,2 88,9 101,6 114,3 127,0 139,7 152,4	15,20	31,75	25	4,0	4,0	14,00	17,00	40	5,3	37,0	40	3.400	5.500	4,08 3,58 3,24 3,00 2,83 2,69 2,58 2,48 2,41	
<ul style="list-style-type: none"> • NU67/762 • NU67/889 • NU67/1016 • NU67/1143 • NU67/1270 • NU67/1397 • NU67/1524 • NU67/1651 • NU67/1778 • NU67/1905 • NU67/2032 	76,2 88,9 101,6 114,3 127,0 139,7 152,4 165,1 177,8 190,5 203,2	19,05	47,50	40	5,0	4,0	19,00	23,75	60	5,8	45,0	49	6.700	12.500	7,53 6,86 6,35 5,96 5,65 5,39 5,18 5,00 4,84 4,71 4,59	

* T Carico di rottura per catene con piastre trattate / Breaking load with heat treated plates

CATENE TRASPORTO NON UNIFICATE

NON STANDARD CONVEYOR CHAINS

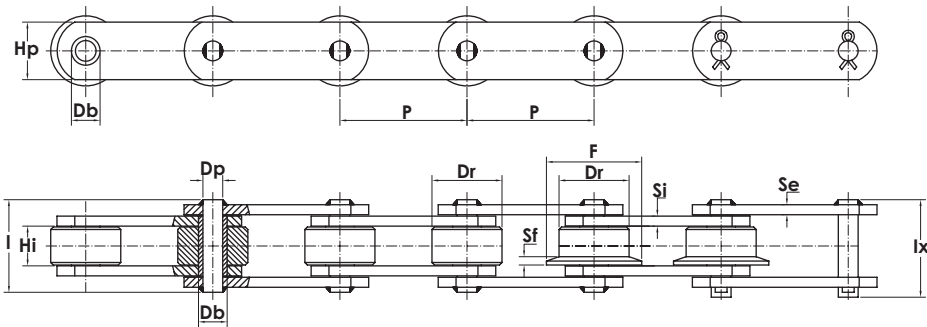

PERNI PIENI RULLI PIANI - SOLID PINS PLAIN ROLLERS

CODICE CATENA	Dimensioni nominali			Altre dimensioni										Carico minimo di rottura		Peso netto al m. Kg/m	TRADE MARK
	passo	largh. interna min.	diam. rullo	altezza max piastra	spess. piastre int.	spess. piastre est.	diam. max perno	diam. bussola	diam. flangia	spess. flangia	largh. perno ribad	ingombro max	N	T*			
	P mm	Hi mm	Dr mm	Hp mm	Sj mm	Se mm	Dp mm	Db mm	F mm	Sf mm	I mm	Ix mm	Kg	Kg			
<ul style="list-style-type: none"> • NU101/1016 • NU101/1143 • NU101/1270 • NU101/1397 • NU101/1524 • NU101/1651 • NU101/1778 • NU101/1905 • NU101/2032 • NU101/2286 • NU101/2540 	101,6 114,3 127,0 139,7 152,4 165,1 177,8 190,5 203,2 228,6 254,0	25,40	66,70	50	7,0	5,0	27,00	32,00	85	8	58,0	63,0	13.600	20.000	13,44 12,47 11,70 11,06 10,53 10,09 9,70 9,37 9,08 8,59 8,20	EURO CATENE	
<ul style="list-style-type: none"> ♦ NU170/1270 ♦ NU170/1397 ♦ NU170/1524 ♦ NU170/1651 ♦ NU170/1778 ♦ NU170/1905 ♦ NU170/2032 ♦ NU170/2286 ♦ NU170/2540 ♦ NU170/2794 ♦ NU170/3048 ♦ NU170/3556 ♦ NU170/4064 	127,0 139,7 152,4 165,1 177,8 190,5 203,2 228,6 254,0 279,4 304,8 355,6 406,4	38,00	89,00	60	9,0	8,0	31,80	38,00	115	10	80,0	87,0	17.000	30.000	25,62 24,02 22,68 21,56 20,59 19,75 19,02 17,79 16,82 16,02 15,35 14,30 13,51		
<ul style="list-style-type: none"> ♦ NU280/2032 ♦ NU280/2540 ♦ NU280/3048 ♦ NU280/3556 ♦ NU280/4064 	203,2 254,0 304,8 355,6 406,4	38,00	89,00	70	10,0	8,0	32,70	38,00	115	10	84,0	92,0	28.000	42.000	21,64 19,29 17,72 16,60 15,76		
<ul style="list-style-type: none"> ♦ NU340/2032 ♦ NU340/2540 ♦ NU340/3048 ♦ NU340/3556 ♦ NU340/4064 	203,1 254,0 304,8 355,6 406,4	38,00	89,00	70	12,0	10,0	32,70	38,00	115	10	92,0	99,0	34.000	55.000	24,49 22,01 20,35 19,17 18,29		

* T Carico di rottura per catene con piastre trattate / Breaking load with heat treated plates

CATENE TRASPORTO NON UNIFICATE

NON STANDARD CONVEYOR CHAINS

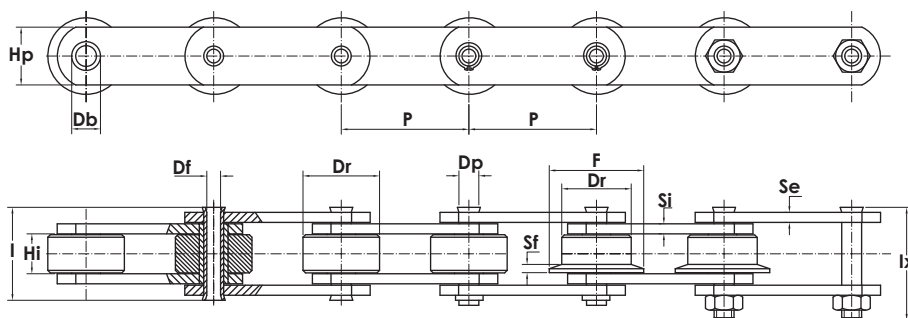

PERNI FORATI RULLI PIANI - HOLLOW PINS PLAIN ROLLERS

CODICE CATENA	Dimensioni nominali			Altre dimensioni										Carico minimo di rottura		Peso netto al m. Kg/m	TRADE MARK
	passo	largh. interna min.	diam. rullo	altezza max piastra	spess. piastre inf.	spess. piastre est.	diam. max perno	diam. foro perno	diam. bussola	diam. flangia	spess. flangia	largh. perno ribad.	ingombro max	N	T*		
	P mm	Hi mm	Dr mm	Hp mm	Si mm	Se mm	Dp mm	Df mm	Db mm	F mm	Sf mm	I mm	Ix mm	N Kg	T* Kg		
<ul style="list-style-type: none"> ♦ NUC17/381 ♦ NUC17/508 ♦ NUC17/635 ♦ NUC17/762 ♦ NUC17/889 ♦ NUC17/1016 	38,1 50,8 63,5 76,2 88,9 101,6	12,7	25,40	19	2,50	1,82	9,53	6,60	13	-	-	26,0	29,2	-	2.050	2,21 1,86 1,65 1,50 1,40 1,33	EURO CATENE
<ul style="list-style-type: none"> • NUC28/508 • NUC28/635 • NUC28/762 ♦ NUC28/889 • NUC28/1016 • NUC28/1143 • NUC28/1270 • NUC28/1524 	50,8 63,5 76,2 88,9 101,6 114,3 127,0 152,4	15,2	31,75	25	4,0	4,0	13,35	10,20	17,00	40	5,3	36,0	39,0	3.200	5.500	3,64 3,23 2,95 2,76 2,61 2,49 2,40 2,26	
<ul style="list-style-type: none"> ♦ NUC67/762 ♦ NUC67/1016 • NUC67/1143 • NUC67/1270 • NUC67/1524 • NUC67/1778 • NUC67/2032 	76,2 101,6 114,3 127,0 152,4 177,8 203,2	19,05	47,50	40	5,0	4,0	19,00	13,20	23,75	60	5,8	44,0	46,0	6.700	12.500	6,84 5,84 5,50 5,24 4,84 4,55 4,34	
<ul style="list-style-type: none"> ♦ NUC101/1016 ♦ NUC101/1270 • NUC101/1524 • NUC101/1778 • NUC101/2032 • NUC101/2286 • NUC101/2540 	101,6 127,0 152,4 177,8 203,2 228,6 254,0	25,4	66,70	50	7,0	5,0	27,00	19,05	32,00	85	8,0	58,0	60,0	10.100	20.000	12,26 10,75 9,75 9,03 8,49 8,07 7,73	
<ul style="list-style-type: none"> ♦ NUC170/1270 ♦ NUC170/1524 ♦ NUC170/1778 ♦ NUC170/2032 ♦ NUC170/2286 ♦ NUC170/2540 ♦ NUC170/2794 ♦ NUC170/3048 ♦ NUC170/3556 	127,0 152,4 177,8 203,2 228,6 254,0 279,4 304,8 355,6	38,0	89,00	60	9,0	8,0	32,50	22,55	38,00	115	10,0	80,0	87,0	17.000	30.000	23,64 21,03 19,17 17,78 16,69 15,82 15,11 14,52 13,59	

* T Carico di rottura per catene con piastre trattate / Breaking load with heat treated plates

ATTACCHI PER CATENE TRASPORTO - NON UNIFICATE

ATTACHMENTS FOR CONVEYOR CHAINS - NON STANDARD

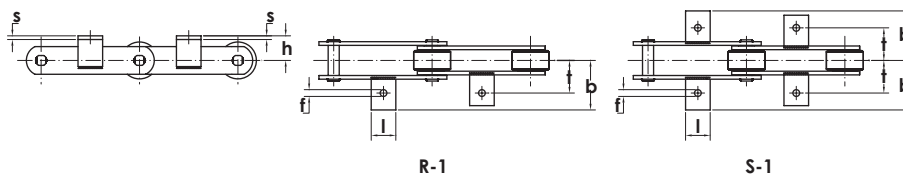

TIPO R-1 S-1 - TYPE R-1 S-1

CODICE CATENA	Passo minimo di applicabilità alle piastre	Dimensioni							Sovrappeso unitario approssimato attacco	
		altezza aletta	lunghezza aletta	diam. fori aletta	interasse trasvers. fori	ingombro trasvers. aletta	spessore aletta	R-1 Kg	S-1 Kg	
		h mm	l mm	f mm	t mm	b mm	s mm			
• NU17	50,8	16	15	6,6	22,0	36,0	2	0,018	0,036	
• NU18	50,8	16	15	6,6	22,0	36,0	2	0,018	0,036	
• NU28	63,5	19	25	9,0	38,0	52,0	3	0,037	0,075	
• NU67	88,9	32	35	11,0	45,0	61,0	4	0,100	0,200	
• NU101	114,3	38	50	14,0	54,0	77,0	5	0,212	0,424	
• NU170	139,7	51	60	18,0	67,0	98,0	6	0,390	0,780	
• NU280	203,2	51	60	18,0	67,0	98,0	6	0,390	0,780	
• NU340	203,2	51	60	18,0	67,0	98,0	6	0,390	0,780	
• NUC17	50,8	16	15	6,6	22,5	36,5	2	0,019	0,038	
• NUC28	63,5	19	25	9,0	38,0	52,0	3	0,037	0,075	
• NUC67	101,6	32	35	11,0	45,0	61,0	4	0,100	0,200	
• NUC101	127,0	38	50	14,0	54,0	77,0	5	0,212	0,424	
• NUC170	152,4	51	60	18,0	67,0	98,0	6	0,390	0,780	

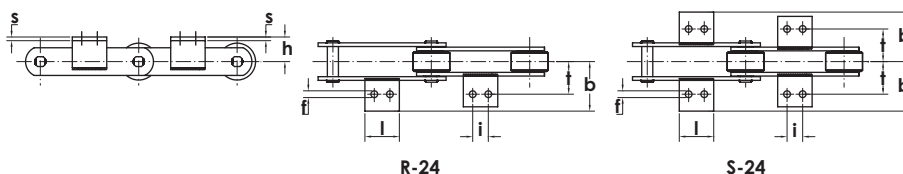

TIPO R-24 S-24 - TYPE R-24 S-24

CODICE CATENA	Passo minimo di applicabilità alle piastre	Dimensioni							Sovrappeso unitario approssimato attacco	
		altezza aletta	lunghezza aletta	diam. fori aletta	interasse trasvers. fori	ingombro trasvers. aletta	interasse longitud. aletta	spessore aletta	R-24 Kg	S-24 Kg
		h mm	l mm	f mm	t mm	b mm	i mm	s mm		
• NU17	63,5	16	35	6,6	22,0	36,0	20	2	0,028	0,056
• NU18	63,5	16	35	6,6	22,0	36,0	20	2	0,028	0,056
• NU28	76,2	19	40	9,0	38,0	52,0	25	3	0,062	0,124
• NU67	101,6	32	50	11,0	45,0	61,0	30	4	0,140	0,280
• NU101	152,4	38	80	14,0	54,0	77,0	50	5	0,340	0,680
• NU170	177,8	51	100	18,0	67,0	98,0	65	6	0,650	1,300
• NU280	203,2	51	100	18,0	67,0	98,0	65	6	0,650	1,300
• NU340	203,2	51	100	18,0	67,0	98,0	65	6	0,650	1,300
• NUC17	63,5	16	35	6,6	22,5	36,5	20	2	0,029	0,059
• NUC28	76,2	19	40	9,0	38,0	52,0	25	3	0,062	0,124
• NUC67	101,6	32	50	11,0	45,0	61,0	30	4	0,140	0,280
• NUC101	152,4	38	80	14,0	54,0	77,0	50	5	0,340	0,680
• NUC170	203,2	51	100	18,0	67,0	98,0	65	6	0,650	1,300

ATTACCHI PER CATENE TRASPORTO - NON UNIFICATE

ATTACHMENTS FOR CONVEYOR CHAINS - NON STANDARD

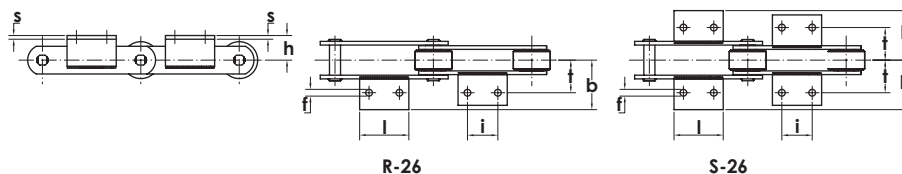

TIPO R-26 S-26 - TYPE R-26 S-26

CODICE CATENA	Passo minimo di applicabilità alle piastre	Dimensioni							Sovrappeso unitario approssimato attacco	
		altezza aletta	lunghezza aletta	diam. fori aletta	interasse trasvers. fori	ingombro trasvers. aletta	interasse longitud. aletta	spessore aletta	R-26 Kg	S-26 Kg
		h mm	l mm	f mm	t mm	b mm	i mm	s mm		
• NU17	88,9	16	55	6,6	22,0	36,0	40	2	0,043	0,085
• NU18	88,9	16	55	6,6	22,0	36,0	40	2	0,043	0,085
• NU28	127,0	19	80	9,0	38,0	52,0	50	3	0,122	0,244
• NU67	152,4	32	90	11,0	45,0	61,0	65	4	0,258	0,516
• NU101	203,2	38	120	14,0	54,0	77,0	85	5	0,510	1,020
• NU170	254,0	51	140	18,0	67,0	98,0	100	6	0,910	1,820
• NU280	254,0	51	140	18,0	67,0	98,0	100	6	0,910	1,820
• NU340	254,0	51	140	18,0	67,0	98,0	100	6	0,910	1,820
• NUC17	88,9	16	55	6,6	22,5	36,5	40	2	0,043	0,085
• NUC28	127,0	19	80	9,0	38,0	52,0	50	3	0,122	0,244
• NUC67	152,4	32	90	11,0	45,0	61,0	65	4	0,258	0,516
• NUC101	203,2	38	120	14,0	54,0	77,0	85	5	0,510	1,020
• NUC170	254,0	51	140	18,0	67,0	98,0	100	6	0,910	1,820

TIPO R-28 S-28 - TYPE R-28 S-28

• NU101	228,6	38	150	14,0	54,0	77,0	100	5	0,640	1,280
• NU170	279,4	51	180	18,0	67,0	98,0	125	6	1,170	2,340
• NUC101	228,6	38	150	14,0	54,0	77,0	100	5	0,640	1,280
• NUC170	279,4	51	180	18,0	67,0	98,0	125	6	1,170	2,340

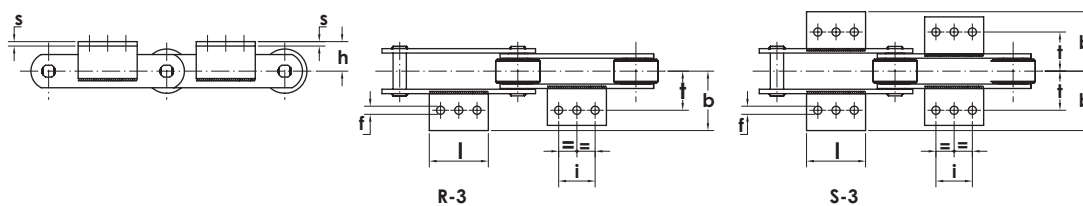

TIPO R-3 S-3 - TYPE R-3 S-3

CODICE CATENA	Passo minimo di applicabilità alle piastre	Dimensioni							Sovrappeso unitario approssimato attacco	
		altezza aletta	lunghezza aletta	diam. fori aletta	interasse trasvers. fori	ingombro trasvers. aletta	interasse longitud. aletta	spessore aletta	R-3 Kg	S-3 Kg
		h mm	l mm	f mm	t mm	b mm	i mm	s mm		
• NU17	88,9	16	55	6,6	22,0	36,0	40	2	0,043	0,085
• NU18	88,9	16	55	6,6	22,0	36,0	40	2	0,043	0,085
• NU28	127,0	19	80	9,0	38,0	52,0	50	3	0,122	0,244
• NU67	152,4	32	90	11,0	45,0	61,0	65	4	0,258	0,516
• NU101	203,2	38	120	14,0	54,0	77,0	85	5	0,510	1,020
• NU170	254,0	51	140	18,0	67,0	98,0	100	6	0,910	1,820
• NU280	254,0	51	140	18,0	67,0	98,0	100	6	0,910	1,820
• NU340	254,0	51	140	18,0	67,0	98,0	100	6	0,910	1,820
• NUC17	88,9	16	55	6,6	22,5	36,5	40	2	0,043	0,085
• NUC28	127,0	19	80	9,0	38,0	52,0	50	3	0,122	0,244
• NUC67	152,4	32	90	11,0	45,0	61,0	65	4	0,258	0,516
• NUC101	203,2	38	120	14,0	54,0	77,0	85	5	0,510	1,020
• NUC170	254,0	51	140	18,0	67,0	98,0	100	6	0,910	1,820

ATTACCHI PER CATENE TRASPORTO - NON UNIFICATE

ATTACHMENTS FOR CONVEYOR CHAINS - NON STANDARD

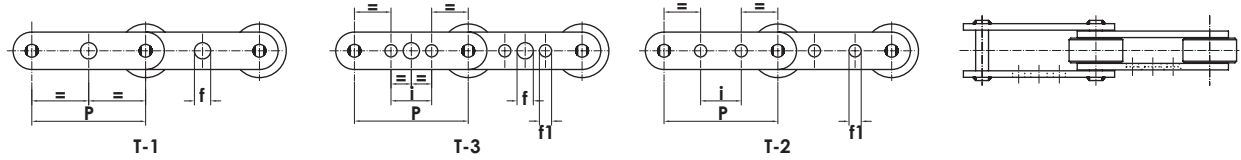

PERNI PIENI - SOLID PINS

TIPO T-1 T-2 T-3 - TYPE T-1 T-2 T-3

CODICE CATENA	Passo minimo di applicabilità per T-2 T-3	Dimensioni		
		diam. foro centrale	diam. fori laterali	interasse fori laterali
		f mm	f ₁ mm	i mm
• NU17	101,6	7	6	50
• NU18	101,6	7	6	50
• NU28	127,0	11	9	50
• NU67	152,4	15	11	63
• NU101	203,2	15	11	80
• NU170	254,0	21	14	100
• NU280	304,8	21	14	100
• NU340	304,8	21	14	100

PERNI FORATI - HOLLOW PINS

TIPO T-1 T-2 T-3 - TYPE T-1 T-2 T-3

CODICE CATENA	Passo minimo di applicabilità per T-2 T-3	Dimensioni		
		diam. foro centrale	diam. fori laterali	interasse fori laterali
		f mm	f ₁ mm	i mm
• NUC17	101,6	9	7	50
• NU28	127,0	11	9	50
• NU67	152,4	15	11	63
• NU101	203,2	15	11	80
• NU170	254,0	21	14	100

PIASTRE RIALZATE - DEEP LINKS

CODICE CATENA	Dimensioni		STILE PIASTRE	
	rialzo dal centro	altezza piastra	•	◆
	Hr mm	Hp mm		
• NU17	17	26	N	S
• NU18	17	26	N	S
• NUC17	16	26	N	S
• NU28-NUC28	27,5	40	N	S
• NU67-NUC67	30	50	N	S
• NU101-NUC101	45	70	N	S
• NU170-NUC170	60	90	N	S
• NU280	70	105	N	S
• NU340	70	105	N	S

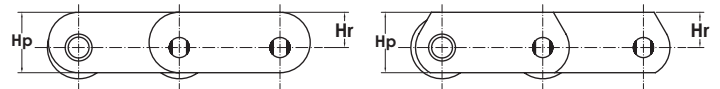

STILE N

STILE S

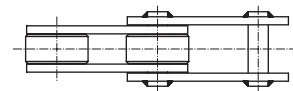

TIPO H-1 - TYPE H-1

CODICE CATENA	Dimensioni			Sovrappeso unitario approx attacco
	diam. perno sporgente	sporgenza da centro catena	sporgenza da piano piast. est.	
	Dp ₁ mm	m mm	n mm	H-i Kg
• NU17	5,70	29,5	18,5	0,004
• NU18	5,70	29,5	18,5	0,004
• NU28	14,00	54,1	38,1	0,039
• NU67	19,00	63,5	44,5	0,248
• NU101	27,00	82,4	57,2	0,435
• NU170	32,70	106,4	69,9	0,435
• NU280	32,70	107,5	69,9	0,435
• NU340	32,70	111,4	69,9	0,435

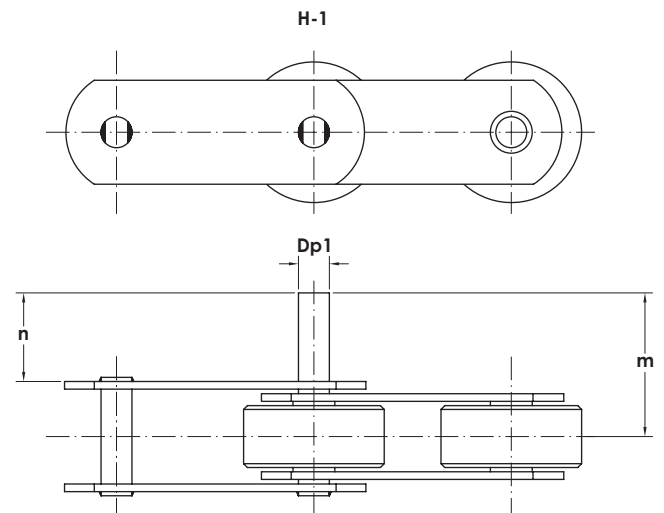

CATENE TRASPORTO A STANDARD INTERNO

CONVEYOR CHAINS OUR STANDARD

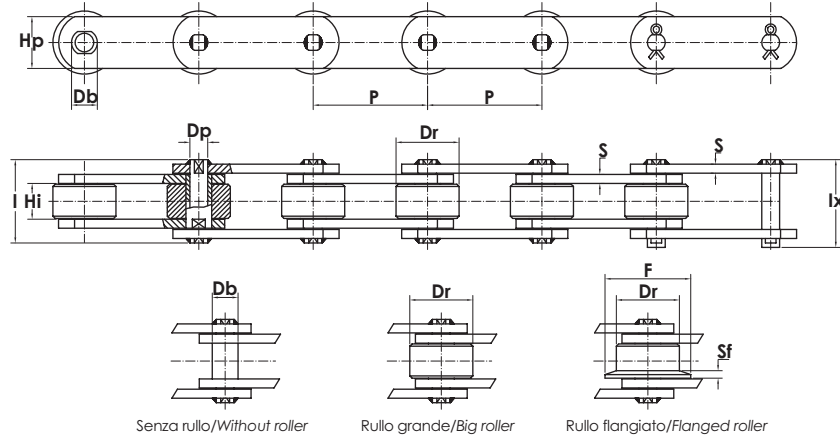

PERNI PIENI RULLI PIANI - SOLID PINS PLAIN ROLLERS

CODICE CATENA	Dimensioni nominali			Altre dimensioni								Carico minimo di rottura		Peso netto al m. Kg/m	TRADE MARK
	passo	largh. interna min.	diam. rullo	altezza max piastra	spess. piastre int.	diam. max perno	diam. bussola	diam. flangia	spess. flangia	largh. perno ribad	ingombro max	N	T*		
	P mm	Hi mm	Dr mm	Hp mm	Si mm	Dp mm	Db mm	F mm	Sf mm	I mm	Ix mm	Kg	Kg		
• ST50/75 • ST50/100 • ST50/125 • ST50/150 • ST50/200	75 100 125 150 200	18,0	38,0	30	4,0	10,0	13,35	45	4,5	41,0	46,0	5.000	9.800	4,55 3,89 3,49 3,22 2,89	EURO CATENE
• ST72/75 • ST72/100 • ST72/125 • ST75/150 • ST75/200	75 100 125 150 200	22,0	40,0	35	4,0	12,0	18,00	48	5,0	45,0	49,0	8.200	11.200	5,84 4,93 4,93 4,02 3,57	
• ST75/100 • ST75/125 • ST75/150 • ST75/200	100 125 150 200	25,0	45,0	35	5,0	14,0	20,00	55	5,0	53,0	58,0	9.000	12.000	6,60 5,83 5,32 4,68	
• ST100/100 • ST100/125 • ST100/150 • ST100/200	100 125 150 200	25,0	50,0	40	5,0	14,0	20,00	65	6,0	53,0	58,0	10.000	15.000	7,92 6,97 6,33 5,53	
• ST110/100 • ST110/125 • ST110/150 • ST110/200	100 125 150 200	30,0	60,0	40	6,0	16,0	22,00	75	7,0	61,0	69,0	11.000	17.000	11,41 9,88 8,86 7,59	
• ST140/125 • ST140/150 • ST140/200 • ST140/250	125 150 200 250	35,0	65,0	50	6,0	18,0	24,00	80	8,0	67,0	75,0	14.000	23.000	13,30 11,87 10,08 9,01	
• ST160/150 • ST160/200 • ST160/250 • ST160/300	150 200 250 300	40,0	70,0	50	8,0	20,0	30,00	90	8,5	81,0	90,0	16.000	24.500	15,75 13,38 11,96 11,02	
• ST195/150 • ST195/200 • ST195/250 • ST195/300 • ST195/350	150 200 250 300 350	45,0	80,0	60	8/10	22,8	36,00	100	10,0	90,0	100,0	19.500	32.000	22,68 19,13 17,00 15,58 14,57	

* T Carico di rottura per catene con piastre trattate / Breaking load with heat treated plates

CATENE TRASPORTO A STANDARD INTERNO

CONVEYOR CHAINS OUR STANDARD

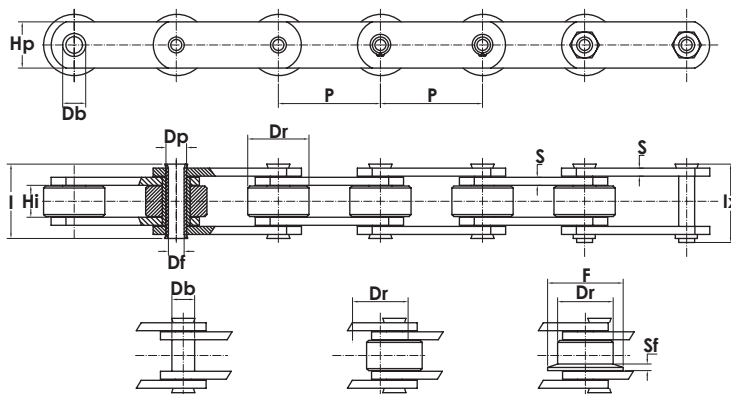

PERNI FORATI RULLI PIANI - HOLLOW PINS PLAIN ROLLERS

CODICE CATENA	Dimensioni nominali			Altre dimensioni										Carico minimo di rottura		Peso netto al m. Kg/m	TRADE MARK
	passo	largh. interna min.	diam. rullo	altezza max piastra	spess. piastre inf.	diam. max perno	diam. foro perno	diam. bussola	diam. flangia	spess. flangia	largh. perno ribad	ingombro max	N Kg	T* Kg			
	P mm	Hi mm	Dr mm	Hp mm	Si mm	Dp mm	Df mm	Db mm	F mm	Sf mm	I mm	Ix mm					
<ul style="list-style-type: none"> • STC40/75 • STC40/100 • SCT40/125 • STC40/150 • STC40/200 	75 100 125 150 200	18,0	38,0	30	4,0	13,35	10,2	17,0	45	4,5	40,0	46,0	4.000	5.200	4,24 3,65 3,30 3,07 2,77	EURO CATENE	
<ul style="list-style-type: none"> • STC50/75 • STC50/100 • STC50/125 • STC50/150 • STC50/200 	75 100 125 150 200	22,0	40,0	35	4,0	18,00	12,20	23,75	48	5,0	44,0	50,0	5.000	8.000	5,46 4,65 4,16 3,83 3,42		
<ul style="list-style-type: none"> • STC60/100 • STC60/125 • STC60/150 • STC60/200 	100 125 150 200	25,0	45,0	35	5,0	16,00	11,0	21,0	55	5,0	51,0	59,0	6.000	8.000	6,21 5,52 5,06 4,48		
<ul style="list-style-type: none"> • STC72/100 • STC72/125 • STC72/150 • STC72/200 	100 125 150 200	25,0	50,0	40	5,0	18,00	12,0	24,0	65	6,0	51,0	59,0	7.200	10.600	7,50 6,63 6,05 5,32		
<ul style="list-style-type: none"> • STC62/100 • STC62/125 • STC62/150 • STC62/200 	100 125 150 200	30,0	60,0	40	6,0	22,00	16,0	29,0	75	7,0	60,0	70,0	6.200	9.800	10,53 9,18 8,28 7,15		
<ul style="list-style-type: none"> • STC110/125 • STC110/150 • STC110/200 • STC110/250 	125 150 200 250	35,0	65,0	50	6,0	24,00	18,0	29,0	80	8,0	65,0	75,0	11.000	14.500	12,31 11,05 9,46 8,51		
<ul style="list-style-type: none"> • STC113/150 • STC113/200 • STC113/250 • STC113/300 	150 200 250 300	40,0	70,0	50	8,0	26,00	20,0	34,0	90	8,5	81,0	90,0	11.300	15.800	14,53 12,47 11,23 10,41		
<ul style="list-style-type: none"> • STC170/150 • STC170/200 • STC170/250 • STC170/300 • STC170/350 	150 200 250 300 350	45,0	80,0	60	8/10	30,00	22,0	38,0	100	10,0	90,0	105,0	17.000	24.000	21,09 17,94 16,05 14,78 13,88		

* T Carico di rottura per catene con piastre trattate / Breaking load with heat treated plates

ATTACCHI PER CATENE TRASPORTO A STANDARD INTERNO

ATTACHMENTS FOR CONVEYOR CHAINS - OUR STANDARD

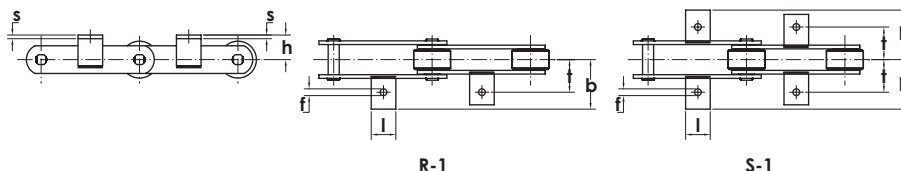

TIPO R-1 S-1 - TYPE R-1S-1

CODICE CATENA	Passo minimo di applicabilità alle piastre	Dimensioni						Sovrappeso unitario approssimato attacco		
		altezza aletta	lunghezza aletta	diam. fori aletta	interasse trasvers. fori	ingombro trasvers. aletta	spessore aletta	R-1 Kg	S-1 Kg	
		h mm	l mm	f mm	t mm	b mm	s mm			
• ST50	75	31		10,5	38	48		4	0,054	0,107
• ST72	75	26		10,5	38	55		4	0,063	0,126
• ST75	100	26		10,5	38	55		5	0,076	0,152
• ST100	100	40		12,5	50	73		6	0,157	0,313
• ST110	100	40		12,5	50	73		6	0,140	0,280
• ST140	125	45		14,5	55	80		6	0,179	0,357
• ST160	150	45		14,5	65	87		8	0,233	0,465
• ST195	150	50		14,5	70	96		9	0,323	0,646
• STC40	75	31		10,5	31	48		4	0,054	0,107
• STC50	75	26		10,5	38	55		4	0,063	0,126
• STC60	100	26		10,5	38	55		5	0,076	0,152
• STC72	100	40		12,5	50	73		6	0,157	0,313
• STC62	100	40		12,5	50	73		6	0,140	0,280
• STC110	125	45		14,5	55	80		6	0,179	0,357
• STC113	150	45		14,5	65	87		8	0,233	0,465
• STC170	150	50		14,5	70	96		9	0,323	0,646

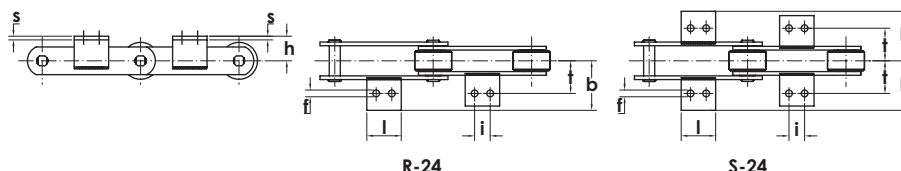

TIPO R-24 S-24 - TYPE R-24 S-24

CODICE CATENA	Passo minimo di applicabilità alle piastre	Dimensioni							Sovrappeso unitario approssimato attacco	
		altezza aletta	lunghezza aletta	diam. fori aletta	interasse trasvers. fori	ingombro trasvers. aletta	interasse longitud. aletta	spessore aletta	R-24 Kg	S-24 Kg
		h mm	l mm	f mm	t mm	b mm	i mm	s mm		
• ST50	75	31	40	10,5	38	48	20	4	0,072	0,143
• ST72	100	26	40	10,5	38	55	20	4	0,084	0,168
• ST75	100	26	40	10,5	38	55	20	5	0,087	0,174
• ST100	100	40	50	12,5	50	73	25	6	0,223	0,446
• ST110	100	40	50	12,5	50	73	25	6	0,200	0,399
• ST140	125	45	60	14,5	55	80	30	6	0,268	0,536
• ST160	150	45	60	14,5	65	87	30	8	0,349	0,698
• ST195	150	50	60	14,5	70	96	30	9	0,431	0,862
• STC40	75	31	40	10,5	31	48	20	4	0,072	0,143
• STC50	100	26	40	10,5	38	55	20	4	0,084	0,168
• STC60	100	26	40	10,5	38	55	20	5	0,087	0,174
• STC72	100	40	50	12,5	50	73	25	6	0,223	0,446
• STC62	100	40	50	12,5	50	73	25	6	0,200	0,399
• STC110	125	45	60	14,5	55	80	30	6	0,268	0,536
• STC113	150	45	60	14,5	65	87	30	8	0,349	0,698
• STC170	150	50	60	14,5	70	96	30	9	0,431	0,862

ATTACCHI PER CATENE TRASPORTO A STANDARD INTERNO

ATTACHMENTS FOR CONVEYOR CHAINS - OUR STANDARD

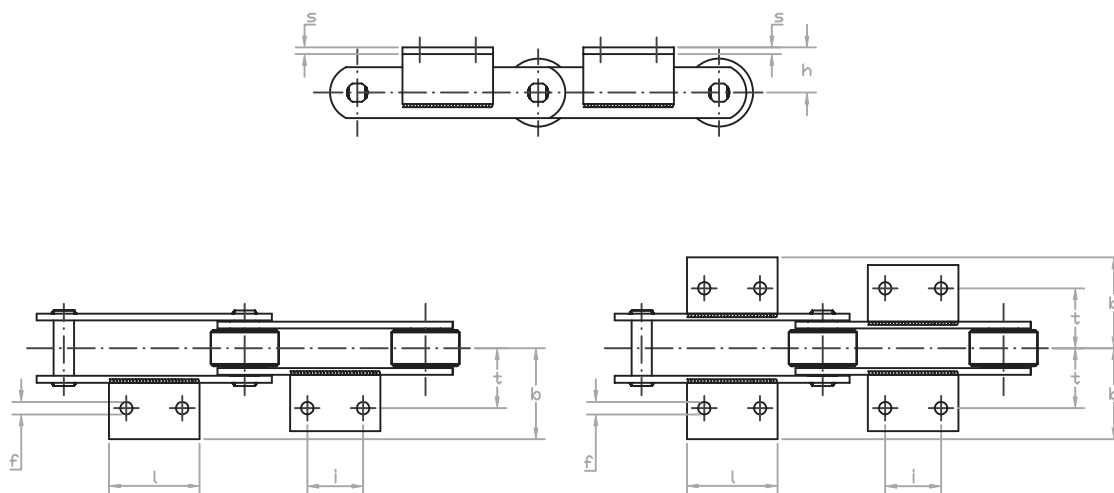

R-26

S-26

TIPO R-26 S-26 - TYPE R-26 S-26

CODICE CATENA	Passo minimo di applicabilità alle piastre	Dimensioni							Sovrappeso unitario approssimato attacco	
		altezza aletta	lunghezza aletta	diam. fori aletta	interasse trasvers. fori	ingombro trasvers. aletta	interasse longitud. aletta	spessore aletta	R-26 Kg	S-26 Kg
		h mm	l mm	f mm	t mm	b mm	i mm	s mm		
• ST50	100	31	60	10,5	38	48	35	4	0,107	0,214
• ST72	100	26	60	10,5	38	55	35	4	0,126	0,252
• ST75	100	26	60	10,5	38	55	35	5	0,131	0,261
• ST100	125	40	65	12,5	50	73	40	6	0,290	0,580
• ST110	125	40	65	12,5	50	73	40	6	0,260	0,519
• ST140	150	45	85	14,5	55	80	55	6	0,380	0,759
• ST160	150	45	85	14,5	65	87	55	8	0,494	0,988
• ST195	150	50	85	14,5	70	96	55	9	0,611	1,221
• STC40	100	31	60	10,5	31	48	35	4	0,107	0,214
• STC50	100	26	60	10,5	38	55	35	4	0,126	0,252
• STC60	100	26	60	10,5	38	55	35	5	0,131	0,261
• STC72	125	40	65	12,5	50	73	40	6	0,290	0,580
• STC62	125	40	65	12,5	50	73	40	6	0,260	0,519
• STC110	150	45	85	14,5	55	80	55	6	0,380	0,759
• STC113	150	45	85	14,5	65	87	55	8	0,494	0,988
• STC170	150	50	85	14,5	70	96	55	9	0,611	1,221

ATTACCHI PER CATENE TRASPORTO A STANDARD INTERNO
ATTACHMENTS FOR CONVEYOR CHAINS - OUR STANDARD

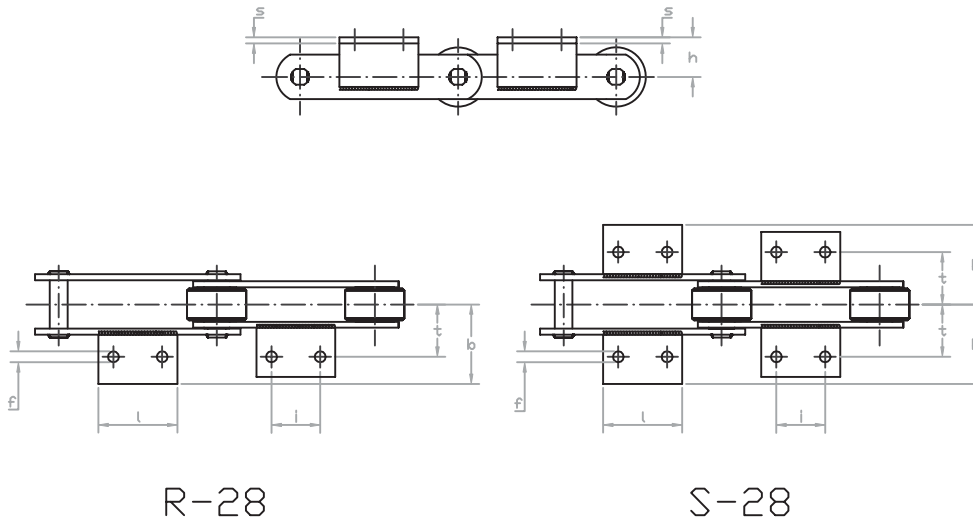

TIPO R-28 S-28 - TYPE R-28 S-28

CODICE CATENA	Passo minimo di applicabilità alle piastre	Dimensioni							Sovrappeso unitario approssimato attacco	
		altezza aletta	lunghezza aletta	diam. fori aletta	interasse trasvers. fori	ingombro trasvers. aletta	interasse longitud. aletta	spessore aletta	R-28 Kg	S-28 Kg
		h mm	l mm	f mm	t mm	b mm	i mm	s mm		
• ST50	125	31	75	10,5	38	48	50	4	0,134	0,267
• ST72	125	26	75	10,5	38	55	50	4	0,158	0,315
• ST75	125	26	75	10,5	38	55	50	5	0,163	0,326
• ST100	150	40	100	12,5	50	73	60	6	0,446	0,892
• ST110	150	40	100	12,5	50	73	60	6	0,399	0,798
• ST140	200	45	120	14,5	55	80	80	6	0,536	1,071
• ST160	200	45	120	14,5	65	87	80	8	0,698	1,395
• ST195	200	50	120	14,5	70	96	80	9	0,862	1,724
• STC40	125	31	75	10,5	31	48	50	4	0,134	0,267
• STC50	125	26	75	10,5	38	55	50	4	0,158	0,315
• STC60	125	26	75	10,5	38	55	50	5	0,163	0,326
• STC72	150	40	100	12,5	50	73	60	6	0,443	0,892
• STC62	150	40	100	12,5	50	73	60	6	0,399	0,798
• STC110	200	45	120	14,5	55	80	80	6	0,536	1,071
• STC113	200	45	120	14,5	65	87	80	8	0,698	1,395
• STC170	200	50	120	14,5	70	96	80	9	0,862	1,724

ATTACCHI PER CATENE TRASPORTO A STANDARD INTERNO

ATTACHMENTS FOR CONVEYOR CHAINS - OUR STANDARD

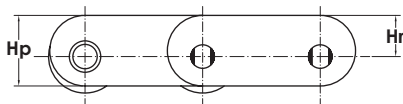

STILE N

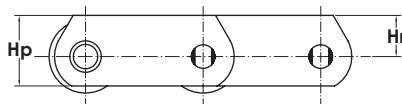

STILE S

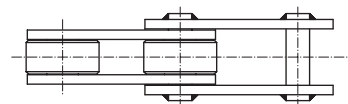

PIASTRE RIALZATE - DEEP LINKS

PERNI PIENI - SOLID PINS

CODICE CATENA	Dimensioni		STILE PIASTRE	
	rialzo dal centro	altezza piastra	•	◆
	Hr mm	Hp mm		
• ST50	25	40	N	S
• ST72	32	50	N	S
• ST75	32	50	N	S
• ST100	35	55	N	S
• ST110	35	55	N	S
• ST140	45	70	N	S
• ST160	45	70	N	S
• ST195	60	90	N	S

PIASTRE RIALZATE - DEEP LINKS

PERNI FORATI - HOLLOW PINS

CODICE CATENA	Dimensioni		STILE PIASTRE	
	rialzo dal centro	altezza piastra	•	◆
	Hr mm	Hp mm		
• STC40	25	40	N	S
• STC50	32	50	N	S
• STC60	32	50	N	S
• STC72	35	55	N	S
• STC62	35	55	N	S
• STC110	45	70	N	S
• STC113	45	70	N	S
• STC170	60	90	N	S

TIPO H-1 - TYPE H-1

CODICE CATENA	Dimensioni			Sovrappeso unitario approx attacco
	diam. perno sporgente	sporgenza da centro catena	sporgenza da piano piastra est.	
	Dp1 mm	m mm	n mm	H-i Kg
• ST50	10,0	37,6	20,1	0,011
• ST72	11,9	44,9	25,4	0,020
• ST75	14,2	63,2	40,2	0,045
• ST100	14,2	63,2	40,2	0,045
• ST110	15,9	73,0	45,5	0,065
• ST140	17,9	80,1	50,1	0,092
• ST160	19,8	89,1	53,4	0,120
• ST195	22,8	100,8	59,8	0,179

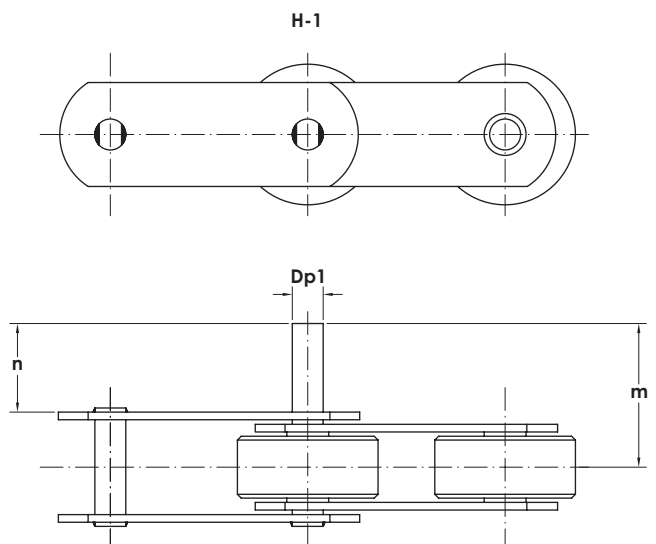

TERMINI DI GARANZIA

La Rosa Catene Spa garantisce i suoi prodotti contro Difetti di Conformità presenti all'origine che vengano denunciati entro i 12 mesi dalla data di acquisto, comprovata da adeguata fattura. Per Garanzia si intende la sostituzione con prodotti nuovi o rigenerati in fabbrica che siano equivalenti per prestazioni ai nuovi prodotti o la riparazione gratuita delle parti componenti il prodotto che presentino Difetti di Conformità accertati e riscontrati dal nostro personale, imputabili ad una azione o omissione da parte della Rosa Catene Spa. Ogni altro indennizzo è escluso, nè potranno essere reclamati danni diretti ed indiretti per temporaneo non utilizzo della merce acquistata. Il cliente, intestatario della fattura di vendita, decade dal diritto alla Garanzia ove non denunci il Difetto di Conformità entro il termine di due mesi dalla scoperta dello stesso.

La Garanzia decade se il prodotto viene danneggiato o reso difettoso in seguito ad uno stoccaggio o uso improprio o non corretto dello stesso e/o se le condizioni di utilizzo / manutenzione / lubrificazione non soddisfano quanto dettato dalla "buona tecnica" e dalle norme di riferimento e/o riportato nei documenti tecnici (cataloghi, disegni, o altro) della Rosa Catene Spa. L'esame dei difetti e delle loro cause sarà sempre effettuato dalla Rosa Catene Spa, anche avvalendosi di laboratori esterni, previa consegna presso la ns. sede produttiva del prodotto supposto non conforme.

Il cliente è tenuto a documentare in maniera inoppugnabile la provenienza del prodotto e le sue coordinate identificative che Rosa Catene Spa inserisce in ogni spedizione in maniera da consentire la tracciabilità del prodotto e dei suoi componenti all'interno del ciclo produttivo della Rosa Catene Spa.

Laddove tali dati non siano forniti si ha decadenza della validità della Garanzia.

In particolare per i prodotti con parti vulcanizzate in gomma si fa presente che la Rosa Catene Spa può garantire l'inalterazione delle caratteristiche fisico-meccaniche della miscela per circa 6 mesi dalla data di fornitura del prodotto in condizioni di corretto stoccaggio, quali :

- non esporre il prodotto alla luce solare diretta e/o alle intemperie.
- mantenere il prodotto ad una temperatura tra i 10°C e i 30°C.

Oltre tale periodo la miscela subisce un naturale decadimento dovuto al fenomeno naturale dell'invecchiamento, più o meno rapido a seconda delle condizioni ambientali e/o di lavoro.

WARRANTY TERMS

Rosa Catene Spa guarantees their products against conformity defects present at the beginning if notified within 12 months from the purchasing date and in possession of their respective invoice.

PARTI STACCATE PER CATENE A RULLI
LOOSE PARTS FOR ROLLER CHAINS

N°40

semplice
single



multipla
multiple

MAGLIA INTERNA
INNER LINK

N°35

semplice
single

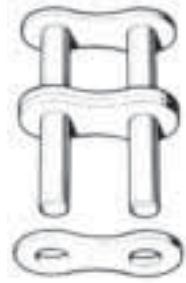

multipla
multiple

MAGLIA ESTERNA
OUTER LINK

N°21

semplice
single

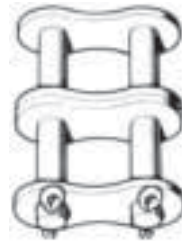

multipla
multiple

GIUNTO CON COPIGLIE
COTTER CONNECTING LINK

N°20

semplice
single



multipla
multiple

GIUNTO CON MOLLETTA
SPRING CLIP CONNECTING LINK

N°26

semplice
single



perno giunto
connecting pin

GIUNTO CON DADO PER PERNI FORATI
NUT CONNECTING LINK FOR HOLLOW PINS

N°27

semplice
single



perno giunto
connecting pin

GIUNTO CON SEEGER PER PERNI FORATI
SEEGER CONNECTING LINK FOR HOLLOW PINS

N°30

semplice
single



multipla
multiple

MAGLIA FALSA DOPPIA
OFFSET SECTION

N°31

semplice
single



multipla
multiple

MAGLIA FALSA CON COPIGLIE
ROLLPIN OFFSET LINK

N°22

PERNO GIUNTO
CONNECTING PIN



N°23

COPIGLIA
COTTER



N°25

MOLLETTA
SPRING CLIP



N°28

DADO
NUT



N°29

SEEGER
SEEGER



La Società **ROSA CATENE** spa ed **EUROCATENE** sas sono presenti con i loro prodotti anche nei seguenti settori:

Richiedete alla nostra sede i cataloghi di Vostro interesse

AGRICOLTURA



TRASPORTO GOMMA



CATENE PER ACCUMULO



TRASPORTO LEGGERO



CATENE RASCHIANTI



TRASPORTO PESANTE



TRASMISSIONE



TRAZIONE



ROSA
EURO
CATENE

FABBRICA CATENE AGRICOLE E INDUSTRIALI
INDUSTRIAL AND AGRICULTURAL CHAIN FACTORY

Via S. Rocco, 5/B - 23801 **CALOLZIOCORTE** (LC) - Italy
Tel. 0039.0341.630.294 - Telefax Italy 0039.0341.631.139 - Telefax Foreign 0039.0341.645.789
www.rosacatene.com - e-mail: rosa@rosacatene.com